

# Soluflex

Flexible · Freedom · Floor

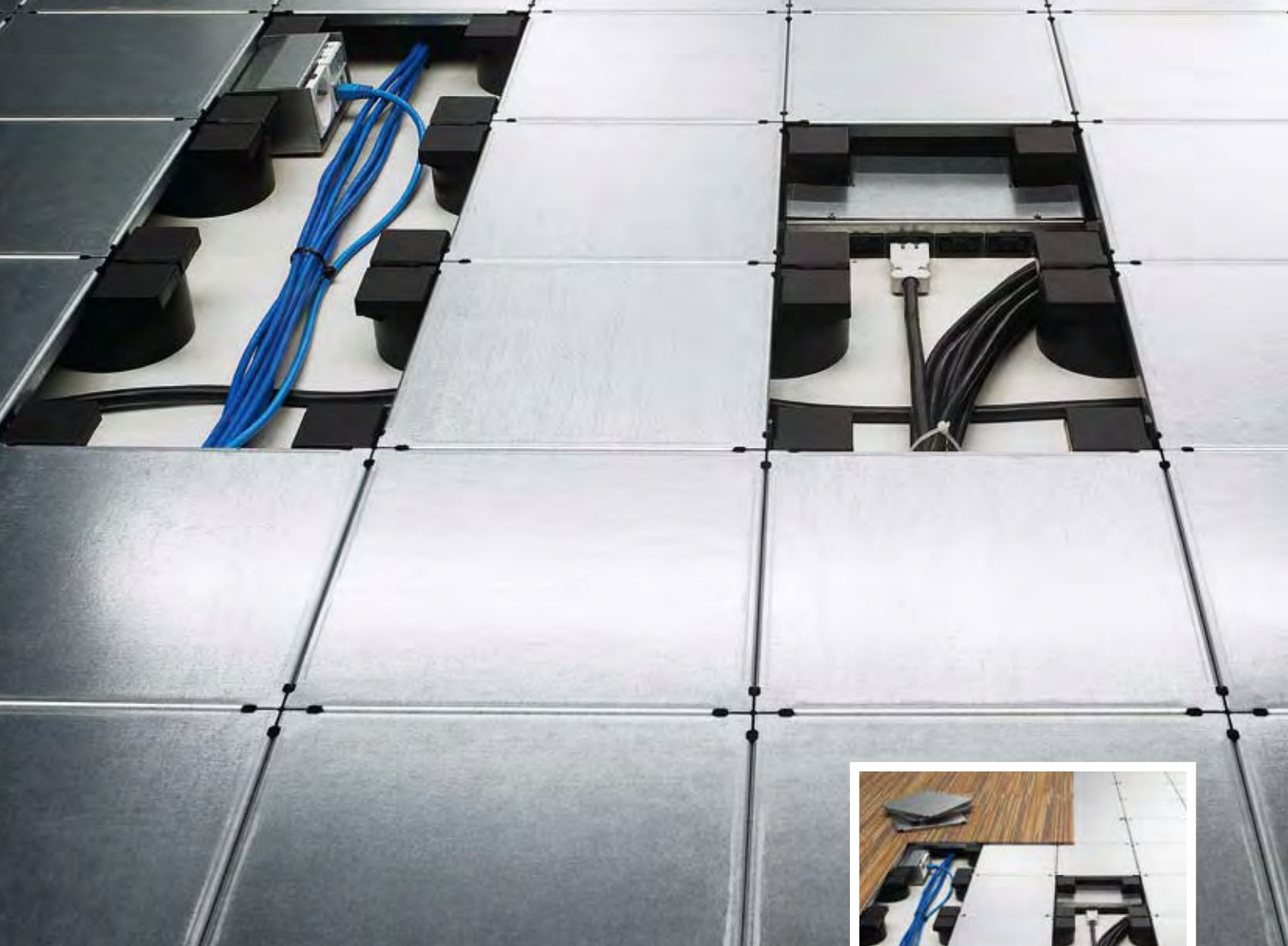

Technical catalogue

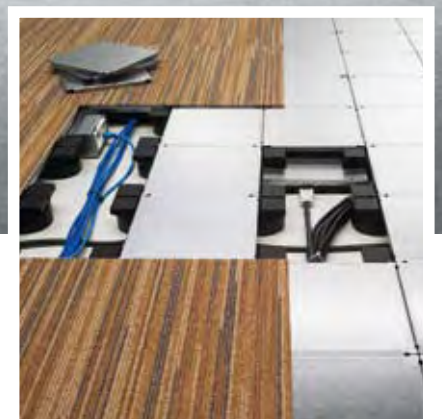



# Index

## Soluflex, the clever floor system

Flexible	4
Freedom	6
Floor	8
Why choose Soluflex?	10
Technical details	12
Four standard floor heights	14

## Technical information

Selection table	16
Product details	18
Dimensions	27
Mounting instructions	34

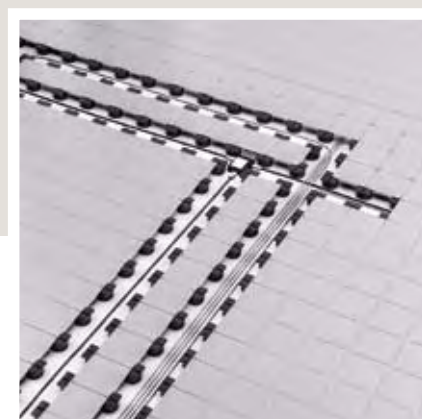
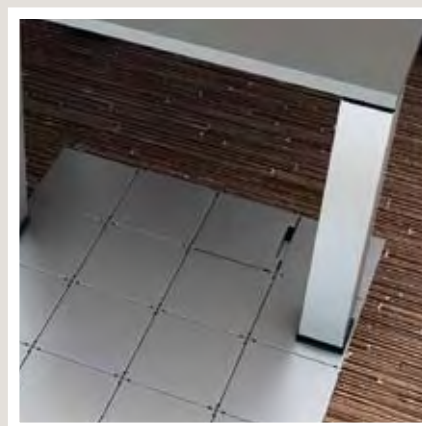
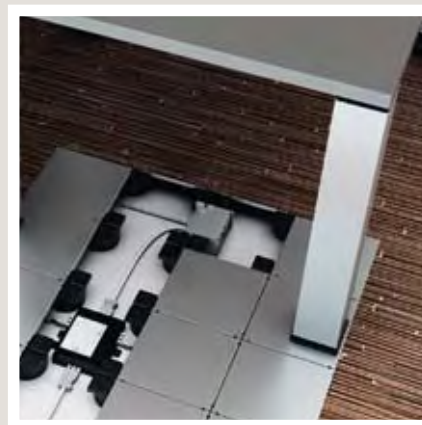



**Soluflex, the clever floor system**

# Flexible

Hundreds of thousands square meters of Soluflex have already been installed around the world for good reason – the Soluflex cable floor system offers flexibility. The Soluflex floor consists of 225 x 225 mm metal tiles, mounted on polypropylene supports. Underneath there is sufficient room for cabling. Cables can be placed in cable paths under the entire floor. Carpet tiles and other floor finishes, such as PVC, stone, rubber or wood, make it complete and give unlimited freedom when designing work places.

For old buildings, new housing and renovation projects Soluflex always offers the best solution. The supports come in different heights: 37, 60, 90 and 120 mm. The system is ideally suited for renovation projects. Old buildings particularly have a great need for additional electrical infrastructure, and (Soluflex height of 37 mm) makes this possible and creates maximum flexibility. In new developments, there are no limitations in the design stage as the precise location of electricity and data cables can be determined in the last phase of the building process.

The floor is quickly, easily and noiselessly installed. You can choose out of a large number of components and accessories to complete the floor system. The low plenum height means this cable floor system is self-extinguishing in case a fire starts underneath the floor. In addition to traditional floor systems, Soluflex is very low weight and easy to manage.

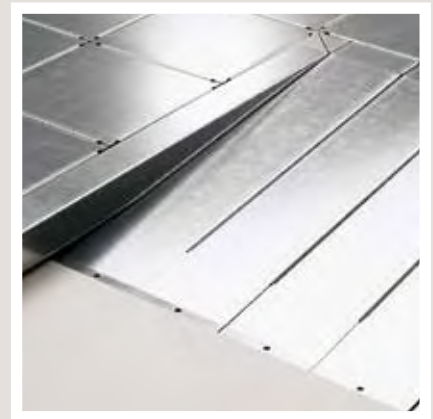



**Soluflex, the clever floor system**

# Freedom

People often don't associate a floor with freedom. Either the Soluflex cable floor system offers both designer and user the utmost freedom. Freedom in design because, really, everything is possible - the result is always a wonderful smart floor and an interior free from ugly cables. Managers of office buildings can achieve considerable cost savings when companies relocate, but on top of this, work place connections can be installed within a short time, without power cuts or data network disconnections. Reconfigurations of the office space can easily be carried out by the enduser himself, during working hours. The Soluflex cable floor system provides great freedom when installing new cables as part of renovation projects. The end users have the total freedom to meet all of their individual wishes, combined with a perfect connection to all the necessary networks. The way in which offices are arranged will no longer be determined by how the cables are installed. Located away from the wall, with glass façades in mind, this view or that amount of light - everything is possible. Untidy cables under desks are a thing of the past.

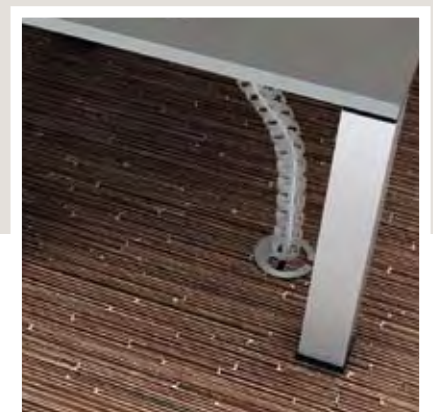
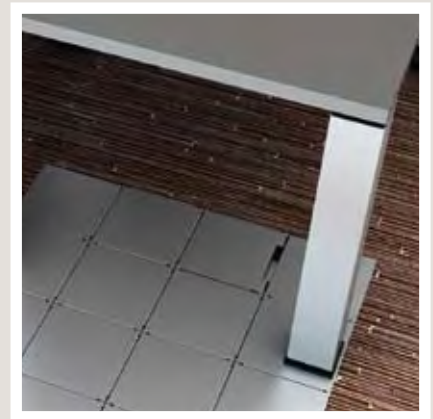



**Soluflex, the clever floor system**



# Floor

A floor is literally the base on which the work takes place. Time spent on considering the functionality of the infrastructure under the floor and looking ahead will definitely be worth the effort. By choosing this practical, flexible and attractive floor system, efficiency and productivity are boosted. Drastic conversion projects is something of the past and with a life cycle of approximately 40 years, you only need to choose Soluflex once. After that, the users will only experience the benefit.

The Soluflex cable floor system is much more than just a raised floor – it's a floor, cabling system and connection technology all rolled into one, an electronic highway under your feet. All power cables, data and telecommunications are conveniently organized and completely out of sight. A technician can easily make alterations to the system and enlargements or re-routings are very quick and easy to carry out without demolishing the building. A good investment in flexibility, freedom, ease of use, endurance and simplicity.





Soluflex, the clever floor system

# Why choose Soluflex?

## Architects

- Great freedom of design, no suspended ceiling required, glass walls from the floor upwards are also possible
- This cable management system is in case of fire self-extinguishing
- Low weight of the floor, compared to traditional raised floor
- Wide choice of floor covering like carpet, rubber, PVC, wooden and stone tiles
- All materials can be recycled
- Very high performance, up to 6 times more distributed load capacity than traditional raised floor systems
- Sound insulation: like walking on a concrete floor, no hollow sound production

## Facility manager

- Enormous cost savings when relocating
- Freedom of choice in carpet tiles and other floor coverings
- Workplace connections to be realised in a very short time without interruptions or disconnection of power or data connections
- Reliable and simple system
- Enormous freedom of cabling and cabling capacity in renovation projects
- Workplace changes simple to realise by your own staff
- Changing of office configurations. Fast, no skilled labour required, no limits to frequency of churn rate
- Shell&Core projects: easy to install flooring in a late stage, tenant can make final decisions last minute

## Investor/project developer

- Shell&Core projects: tenants can make choice in a very late stage without facing any disadvantages later on
- Complete floor can be moved to another location whenever needed
- Installation has no impact whatsoever on the building structure; no drilling of any kind

## New buildings

- Long life cycle
- The user can optimally arrange the office
- Building and office space can be changed or partitioned economically when there is a change of user

## Renovation

- Low height
- No or minor adjustments of the building required
- Maximum room to move
- Simple renewal of carpet tiles (no stripping of tiles)

## Electrical adviser / M&E consultant

- Unlimited cable capacity
- Free arrangement of outlet units
- Outlet units can be determined in a very late stage
- Cable management system with integrated outlet units to be arranged according to the requirements of the client
- Various options of outlet units available
- Earthing only once per 100m<sup>2</sup>
- No cable damage possible thanks to round supports

## Installer / Contractor

- Installation possible in a very short time: double as fast as traditional raised flooring systems
- Various prefab systems available
- Changes or adjustments to the system can be made at a later stage if necessary
- Cable management system is available including installation
- Various client-specific solutions available
- No skilled labour required
- No leveling of the floor required
- Small tiles, extremely easy to handle and easy to cut
- Easy stocking and less space consuming than traditional raised flooring systems
- Optimal transport features, a container fits double the amount of m<sup>2</sup> than a traditional raised floor system





**Soluflex, the clever floor system**

# Technical details

## Material

- The floor tiles are made of pregalvanised steel, according to EN 10326.
- The supports are made of recycled polypropylene.

## Weights and measures

- Dimensions of tiles: 225x225 mm.
- Available in four different heights: 37, 60, 90 and 120 mm.
- Weight of the Soluflex® cable floor system, approx 20 kg/m<sup>2</sup>.
- Maximum uniform distributed load: 3,000 N.
- Maximum point load per tile/support: 1500N/ 625 mm<sup>2</sup>.

## Acoustic characteristics

Flanking air sound insulation in accordance with ISO 717-1: 1996. Tested according to ISO 140-12:2000

- Soluflex® cable floor system without mineral wool underneath the partition wall: 48 dB.
- Soluflex® cable floor system with mineral wool underneath the partition wall: 60 dB. Vertical impact sound insulation improvement in accordance with ISO 140-12:2000
- Soluflex® cable floor system with carpet and without mineral wool underneath the partition wall:  $L_{n,f,w} = 49\text{dB}$ .
- Soluflex® cable floor system with carpet and with mineral wool underneath the partition wall:  $L_{n,f,w} = 39\text{dB}$ .

Vertical impact sound level of a floor finish in accordance with ISO. The improvement in soundproofing is measured in the underlying floor.

- Impact sound insulation of a floor finish according to ISO 717-2:1996. Tested according to ISO 140-6:1998

- Concrete floor 140 mm + Soluflex  
 $\Delta L_w = 17\text{ dB}$   
 $\Delta L_{lin} = 7\text{ dB}$
- Concrete floor 140 mm + Soluflex + carpet tiles  
 $\Delta L_w = 24\text{ dB}$   
 $\Delta L_{lin} = 12\text{ dB}$

## Other features

- The sub-floor should be dry, clean and levelled, suitable for carpeting.
- The cable floor system feels steady. Since the floor is not adjustable in height, it needs no later adjustment.
- The diagonal structure of the Soluflex floor means the cables are perfectly parallel, and you can cross data cables at the required angle of 90°.

## TNO fire

Fire resistance.

The low plenum height means that the cable floor system is self-extinguishing.

- NEN-EN 13501-1:  
B(fl) S1-d0
- NEN 1775:  
A - Inflammability – Complies with the class T1 criteria for inflammability.  
B - Horizontal flame spread: All thicknesses – maximal horizontal flame spread = 0 cm, signifying a critical heat flow density of more than 11 kW/m<sup>2</sup>. Classification according to NEN 1775: Class T1.
- NEN 6066:  
For maximum heat flow of 50 kW/m<sup>2</sup>: Maximum indicative smoke density less than 0.5 m<sup>-1</sup>, signifying a very weak smoke emission in the case of fire.



Soluflex, the clever floor system

# Four standard floor heights

## **Soluflex H = 37 mm**

The 37 mm high version has been developed especially for renovation projects. Under less than 4 cm floor elevation all thinkable cabling is possible without cutting or breaking. Maximum room to move, remains above the floor. Also old rooms with low ceilings are updated this way. If the door doesn't allow further elevation of the floor, then you can begin installing the cable floor system a little bit further by using special ramps.

The high-tech of the Soluflex cable floor system is hidden under a taut and neutral look, a major advantage with the renovation of characteristic old buildings.

Old buildings are equipped for ready for the requirements of the future without affecting the authentic atmosphere.

## **Soluflex H = 60 mm**

With this height you can use special wiring devices, junction boxes and plugs, plus the traditional accessories you already know. The possibilities are unlimited. The wiring devices are flush and invisible. There are outlet units of the size of one tile as well as large lid & frame assemblies of the size of four tiles. For electricity, telecommunication, data traffic or for all possible combinations. You can compose the outlet units yourself, but you can also choose for pre-wired models. The cabling can be led up with a cable worm from the floor direct to the desk. It is also possible to have connections on the workplace itself without loose cables lying about.

## **Soluflex H = 90 mm en 120 mm**

The 90 mm & 120 mm high Soluflex floor also leave enough room for bulk cabling and outlet units. Specially for your application in data centers, server rooms or solutions with air conditioning or pipes integrated in the floor. Various models of pre-wired lid & frame assemblies are available. The cabling can be guided up further from the floor. It is even possible to make connections at the workplace itself. Built-in tiles are available for mounting lid & frame assemblies in the traditional shapes square, round and rectangular. The traditional wiring devices fit into these. You can create the outlet units for electricity, telecommunication and data yourself in these lid & frame assemblies.

A wide range of floor boxes are available for direct access to your connections.

The fully submerged units standard for the floor height 60 mm are also available with a height of 90 mm & 120 mm on request.

## selection table Soluflex Cable Floor System

H = 37/60/90/120 mm

	Tile	Support	Project edge finishing	Edge finishing	Plenum-sealing	Plenum exterior angle	Ramp	Earthing tile	Cable outlet tile
H = 37 mm	84000 10	84037 00	84000 60	84000 61	84037 20	84037 30	84037 40	84000 20	84000 30
H = 60 mm	84000 10	84060 00	84000 60	84000 61	84060 20	84060 30	84060 40	84000 20	84000 30
H = 90 mm	84000 10	84090 00	84000 60	84000 61	84090 20	84090 30	84090 40	84000 20	84000 30
H = 120 mm	84000 10	84120 00	84000 60	84000 61	84120 20	84120 30	84120 40	84000 20	84000 30

	Fully submerged unit square 45 2 x 230V (pre-wired)	Fully submerged unit square 45 DATA (empty)	Fully submerged unit universal (empty)	Built-in tile square	Plastic lid assembly square	Build-in unit data (empty)	Build-in unit 230V <sup>(2)</sup>	Support frame <sup>(3)</sup>	Lid & frame assembly square
H = 37 mm	-	-	-	-	-	-	-	-	-
H = 60 mm	84060 78	84060 73	84060 50	84090 51	84532 02	84060 74	84060 77	81905 xx	
H = 90 mm	-	-	-	84090 51	84532 02	84060 74	84060 77	81905 xx	84538 52
H = 120 mm	-	-	-	84090 51	84532 02	84060 74	84060 77	81905 xx	84538 52

(1) Also available empty ref.no. 84000 70 or as junction box data 8 V ref.no. 8400 71



(2) Also available empty ref.no. 84060 69





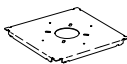

(3) Various models available, suitable for various brands of connectors.

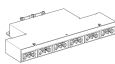
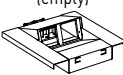
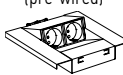
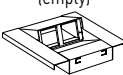
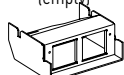
It is possible to make all fitting tot wall with tiles (= option 1). This is cheaper in material, but the use of project edge finishing (= option 2) will be faster in installation.

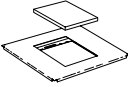
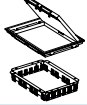
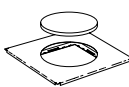

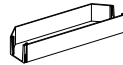

Lead outlet	Surface-mounted tile	Fixing bracket	Junction box 6V	Junction box 6V <sup>(1)</sup>	Built-in square 45 2 x 230V (empty)	Built-in square 45 2 x 230V (pre-wired)	Built-in square 45 2 x data (empty)	Fully submerged unit square 45 2 x 230V (empty)
								
81902 32	84000 40	84000 50	81905 09	84000 77	84037 50	84037 57	84037 51	-
81902 32	84000 40	84000 50	81905 09	84000 77	-	-	-	84060 72
81902 32	84000 40	84000 50	81905 09	84000 77	-	-	-	-
81902 32	84000 40	84000 50	81905 09	84000 77	-	-	-	-

Built-in tile rectangular	Lid & frame assembly rectangular	Built-in tile round	Lid & frame assembly round	Mounting box small	Mounting plate M45 small	Mounting box large	Mounting plate M45 large	Strain relief
								
-	-	-	-	-	-	-	-	-
-	-	-	-	-	-	-	-	-
84090 61	84538 51	84090 71	84548 53	84550 01	84550 31	84550 02	84550 32	84550 06
84090 61	84538 51	84090 71	84548 53	84550 01	84550 31	84550 02	84550 32	84550 06





**Column solution**



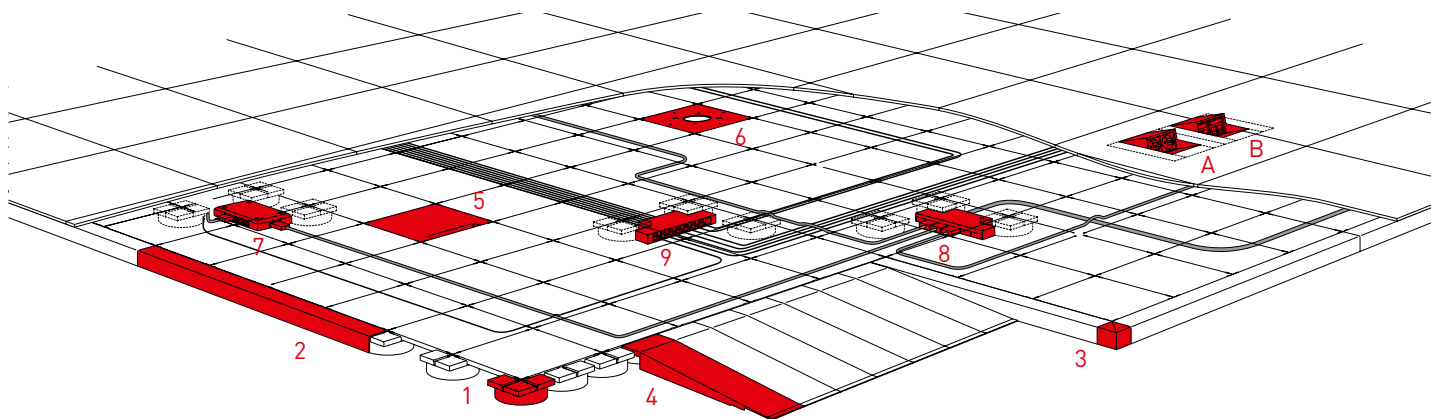

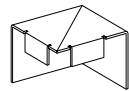
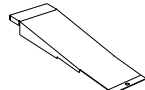

# Soluflex Cable Floor System

H = 37 mm

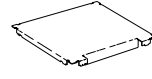

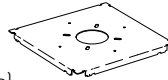
Verp.	Ref.nr.	Floor parts	
		<b>Tile</b>	
1	84000 10	Pregalvanised Square 225 mm H = 13 mm Equipped with 4 contact/distance cams	
		<b>Support 1</b>	
1	84037 00	Black Polypropylene Square 100 mm With 2 square grooves in which tiles can be positioned	
		<b>Project edge finishing</b>	
1	84000 60	Pregalvanised L = 900 mm, B = 300 mm 2x turned sides of 13 mm Saw to size on-site for connections on the wall	
		<b>Edge finishing</b>	
1	84000 61	Pregalvanised L = 900 mm, B = 300 mm 1x turned sides of 13 mm Saw to size on-site for connections on the wall	
		<b>Plenum sealing 2</b>	
1	84037 20	Pregalvanised H = 37 mm, L = 900 mm, B = 56 mm For sealing the floor in the free space	
		<b>Plenum exterior angle 3</b>	
1	84037 30	Pregalvanised 56 x 56 mm	
		<b>Ramp 4</b>	
1	84037 40	Pregalvanised Ramp 10% Length 400 mm, width 112 mm Include 1 extra support ref.no. 84037 00 per ramp	

Verp.	Ref.nr.	Floor parts (continued)	
		<b>Earthing tile</b>	
1	84000 20	Pregalvanised Square 225 mm H = 13 mm Earthing clamp 6 mm <sup>2</sup> (max.) 1 tile per 100 m <sup>2</sup> or in gangways max. 14 metres apart Equipped with 4 contact/distance projections	
		<b>Cable outlet tile 5</b>	
1	84000 30	Pregalvanised Square 225 mm H = 13 mm Recess 125 x 15 mm For lead-through to the workplace Equipped with 4 contact/distance projections	
		<b>Lead outlet</b>	
1	81902 32	Chromed Apply with surface-mounted tile ref.no. 84000 40 For lead-through to the workplace	
		<b>Surface-mounted tile 6</b>	
1	84000 40	Pregalvanised H = 13 mm For colonnettes, pedestals + cable worm (see chapter power poles) and lead outlet (ref.no. 81902 32) Square 225 mm Equipped with 4 contact/distance projections	
		<b>Fixing bracket</b>	
1	84000 50	Pregalvanised For mounting colonnette (see power poles) onto the constructional floor with surface-mounted tile ref.no. 84000 40	

# Soluflex Cable Floor System

H = 37 mm (continued)



# Soluflex Cable Floor System

## mounting drawings

H = 37 mm



84000 10



84037 00

Verp.	Ref.nr.	Outlet units	
1	81905 09	<b>Junction box 6 V 7</b> Plastic (black) 1 input GST 18, 1 output GST 18 Pre-wired with 6 branchings GST 18	
1	84000 77	<b>Junction box 6 V 8</b> Pregalvanised 1 input YMVK, 1 output YMVK or lead Pre-wired with 6 branchings Fast Connector and equipped with connection terminal with strain relief	
1	84000 70	Empty	
1	84000 71	<b>Junction box data 8 V 9</b> Recess for RJ 45 connector	
1	84037 50	<b>Built-in square 45 2x 230 V (empty)</b> Pregalvanised Square 225 mm, H = 37 mm Equipped with connection terminal and strain relief Pre-wirable for 2x Mosaic built-in	
1	84037 57	<b>Built-in square 45 2x 230 V A</b> Earthed Pregalvanised Square 225 mm, H = 37 mm, Completely pre-wired with built-in 2x single Mosaic outlet and equipped with connection terminal with strain relief	
1	84037 51	<b>Built-in square 45 2x data B</b> Pregalvanised Square 225 mm, H = 37 mm For built-in 2 x double Mosaic data outlets	

### ■ Mounting drawing 1

Mounting of colonnette using surface-mounted tile and fixing bracket

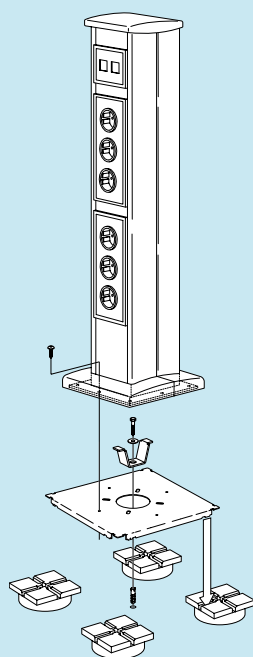

### ■ Mounting drawing 2

Positioning of the junction box

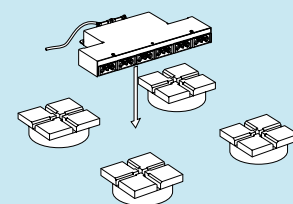

### ■ Mounting drawing 3

Positioning of outlet units

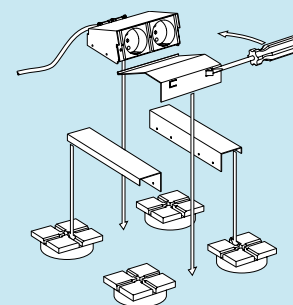

### ■ Mounting drawing 4

Positioning of outlet units

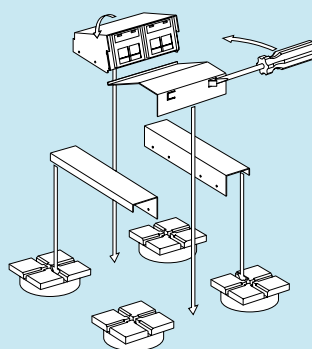

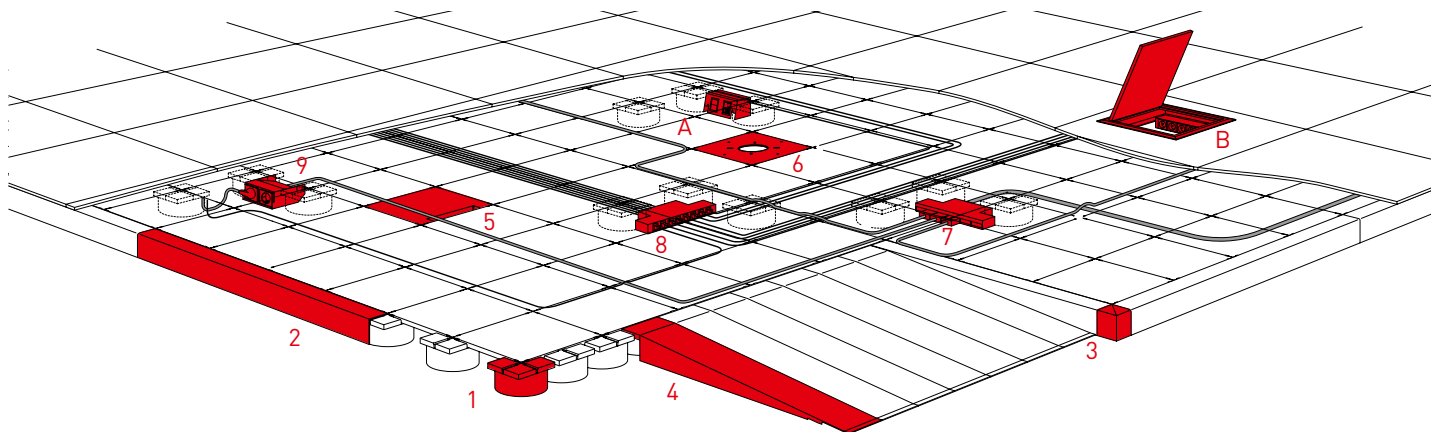

Verp.	Ref.nr.	Floor parts	
		<b>Tile</b>	
1	84000 10	Pregalvanised Square 225 mm H = 13 mm Provided with 4 contact/distance cams	
		<b>Support 1</b>	
1	84060 00	Black Polypropylene Square 100 mm, with 2 square grooves in which tiles can be positioned	
		<b>Project edge finishing</b>	
1	84000 60	Pregalvanised L = 900 mm, B = 300 mm 2x turned sides of 13 mm Saw to size on-site for connections on the wall	
		<b>Edge finishing</b>	
1	84000 61	Pregalvanised L = 900 mm, B = 300 mm 1x turned sides of 13 mm Saw to size on-site for connections on the wall	
		<b>Plenum sealing 2</b>	
1	84060 20	Pregalvanised For sealing the floor in the free space H = 60 mm, L = 900 mm, B = 56 mm	
		<b>Plenum exterior angle 3</b>	
1	84060 30	Pregalvanised 56 x 56 mm	
		<b>Ramp 4</b>	
1	84060 40	Pregalvanised Ramp 10%, L = 616 mm, B = 112 mm Include 1 extra support ref.no. 84060 00 per ramp	
		<b>Earthing tile</b>	
1	84000 20	Pregalvanised Square 225 mm H = 13 mm Earthing clamp 6 mm² (max.) 1 tile per 100 m² or in gangways max. 14 metres apart, provided with 4 contact/distance projections	

Verp.	Ref.nr.	Floor parts (continued)	
		<b>Cable outlet tile 5</b>	
1	84000 30	Pregalvanised Square 225 mm H = 13 mm Recess 125 x 15 mm For lead-through to the workplace Provided with 4 contact/distance projections	
		<b>Lead outlet</b>	
1	81902 32	Chromed Apply with surface-mounted tile ref.no. 84000 40 For lead-through to the workplace	
		<b>Outlet/mounting tile 6</b>	
1	84000 40	Pregalvanised For colonnettes, pedestals + cable worm (see chapter power poles) and lead outlet (ref.no. 81902 32) Square 225 mm H = 13 mm Provided with 4 contact/distance projections	
		<b>Fixing bracket</b>	
1	84000 50	Pregalvanised For mounting colonnette (see chapter on power poles) onto the constructional floor with surface-mounted tile ref.no. 84000 40	
		<b>Outlet units</b>	
		<b>Junction box 6 V</b>	
1	81905 09	Plastic (black) 1 input GST 18, 1 output GST 18 Pre-wired with 6 branchings GST 18	
		<b>Junction box 6 V 7</b>	
1	84000 77	Pregalvanised 1 input YMKV, 1 output YMKV or lead Pre-wired with 6 branchings Fast Connector and provided with connection terminal with strain relief	
		<b>Junction box data 8 V 8</b>	
1	84000 70	Empty	
1	84000 71	Recess for RJ 45 connector	
		<b>Fully submerged unit square 45 2x 230 V</b>	
1	84060 72	Pregalvanised Provided with connection terminal Pre-wirable for 2x Mosaic built-in Combine with cable outlet tile ref.no. 84000 30	

# Soluflex Cable Floor System

H = 60 mm (continued)



# Soluflex Cable Floor System

## mounting drawings

H = 60 mm



84000 10



84060 00

Verp.	Ref.nr.	Outlet units (continued)
1	84060 78	<b>Fully submerged unit square 45 2x 230 V 9</b> Earthed Pregalvanised Completely pre-wired with built-in 2x single Mosaic outlets and equipped with connection terminal Combine with cable outlet tile ref.no. 84000 30
1	84060 72	<b>Fully submerged unit square 45 data</b> Pregalvanised For built-in double Mosaic data Combine with cable outlet tile ref.no. 84000 30
1	84060 50	<b>Fully submerged unit universal A</b> Pregalvanised Possibility for building in data combined with support frame
1	84090 51	<b>Built-in tile square</b> Pregalvanised Square 450 mm For lid & frame assembly square ref.no. 84532 02 Including wooden disposable cover
1	84532 02	<b>Plastic lid assembly square B</b> Plastic with carpet edge Combine with ref.no. 84090 51 and 84060 74 and/or 84060 69, 84060 80
1	84060 74	<b>Lower box data</b> Pregalvanised 4 double building in data Depending on R5 connector to be used with data support frame
1	84060 69	<b>Lower box 230 V</b> Pregalvanised For 4x single Mosaic outlets Available empty and pre-wired
1	84060 77	Empty Prewired Earthed Mosaic outlets
1	81905 00	<b>Support frame for keystone connectors</b> Plastic to be used in combination with: - substructure universal ref.no. 84060 50 - lower box data ref.no. 84060 74
1	81905 01	Red
1	81905 02	Transparent
1	81905 03	Black
1	81905 04	Yellow
1	81905 05	Green
1	81905 06	Orange
1	81905 08	Brown

### ■ Mounting drawing 1

Mounting of colonnette using outlet/mounting tile and fixing bracket

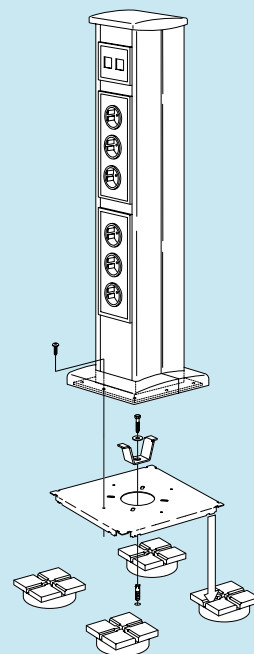

### ■ Mounting drawing 2

Positioning of the junction box

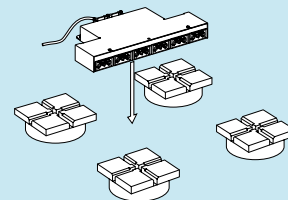

### ■ Mounting drawing 3

Positioning of lower box in combination with cable outlet tile

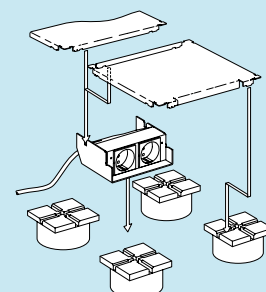

### ■ Mounting drawing 4

Positioning of lower box in combination with cable outlet tile

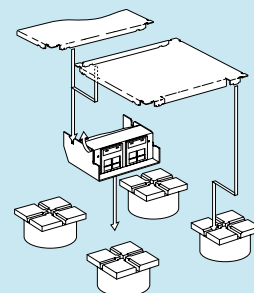

### ■ Mounting drawing 5

Positioning of lower box in combination with cable outlet tile

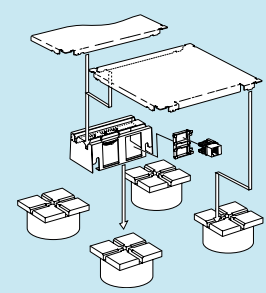

### ■ Mounting drawing 6

Mounting of lid & frame assembly in combination with built-in tile

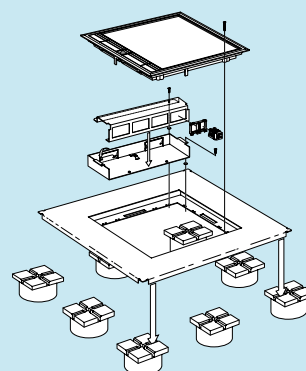

### ■ Mounting drawing 7

Mounting of lid & frame assembly in combination with built-in tile

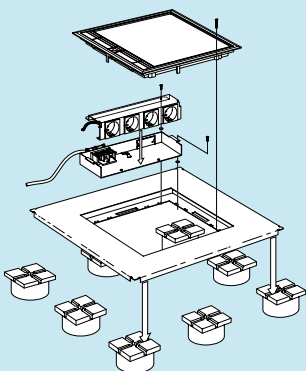

# Soluflex Cable Floor System

H = 90 mm

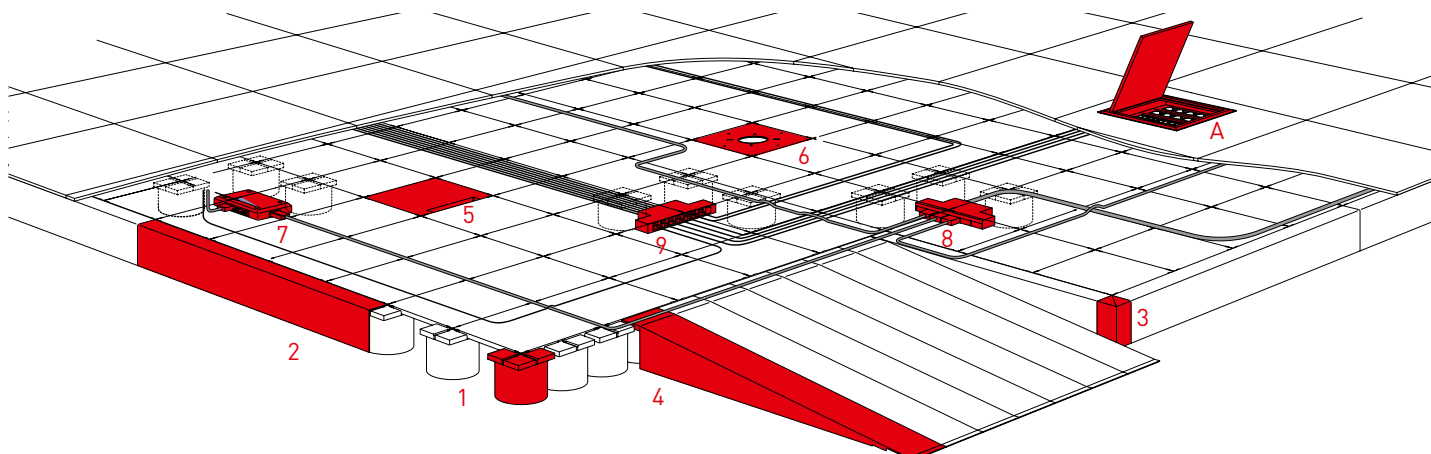

Verp.	Ref.nr.	Floor parts	Verp.	Ref.nr.	Floor parts (continued)
1	84000 10	<b>Tile</b> Pregalvanised Square 225 mm H = 13 mm Provided with 4 contact/distance cams	1	84000 40	<b>Outlet/mounting tile 6</b> Pregalvanised For colonnettes, pedestals + cable worm (see chapter power poles) and lead outlet (ref.no. 81902 32) Square 225 mm H = 13 mm Provided with 4 contact/distance projections
1	84090 00	<b>Support 1</b> Black, polypropylene Square 100 mm With 2 square grooves in which tiles can be positioned	1	84000 50	<b>Fixing bracket</b> Pregalvanised For mounting colonnette (see chapter on power poles) onto the constructional floor with surface-mounted tile ref.no. 84000 40
1	84000 60	<b>Project edge finishing</b> Pregalvanised L = 900 mm, B = 300 mm 2x turned edge of 13 mm Saw to size on-site for connections on the wall			<b>Outlet units</b>
1	84000 61	<b>Edge finishing</b> Pregalvanised L = 900 mm, B = 300 mm 1x turned edge of 13 mm Saw to size on-site for connections on the wall	1	81905 09	<b>Junction box 6 V 7</b> Plastic (black) 1 input GST 18, 1 output GST 18 Pre-wired with 6 branchings GST 18
1	84090 20	<b>Plenum sealing 2</b> Pregalvanised For sealing the floor in the free space H = 90 mm, L = 900 mm, B = 56 mm	1	84000 77	<b>Junction box 6 V 8</b> Pregalvanised 1 input YMVK, 1 output YMVK or lead Pre-wired with 6 branchings Fast Connector and provided with connection terminal with strain relief
1	84090 30	<b>Plenum exterior angle 3</b> Pregalvanised 56 x 56 mm	1	84000 70	Empty
1	84090 40	<b>Ramp 4</b> Pregalvanised Ramp 10% L = 898 mm, B = 112 mm Include 1 extra support ref.no. 84090 00 per ramp	1	84000 71	<b>Junction box data 8 V 9</b> Recess for RJ 45 connector
1	84000 20	<b>Earthing tile</b> Pregalvanised, square 225 mm H = 13 mm Earthing clamp 6 mm <sup>2</sup> (max.) 1 tile per 100 m <sup>2</sup> or in gangways max. 14 metres apart, provided with 4 contact/distance projections	1	84090 51	<b>Built-in tile square</b> Pregalvanised Square 450 mm For lid & frame assembly square ref.no. 84532 02 or 84538 52 Including wooden disposable cover
1	84000 30	<b>Cable outlet tile 5</b> Pregalvanised Square 225 mm H = 13 mm Recess 125 x 15 mm For lead-through to the workplace Provided with 4 contact/distance projections	1	84532 02	<b>Plastic lid assembly square A</b> Plastic with carpet edge Combine with ref.no. 84090 51 and 84060 74 and/or 84060 69, 84060 80
1	81902 32	<b>Lead outlet</b> Chromed Apply with surface-mounted tile ref.no. 84000 40 For lead-through to the workplace	1	84060 74	<b>Lower box data</b> Pregalvanised 4 double building in data Depending on R5 connector to be used with data support frame
			1	84060 69	<b>Lower box 230 V</b> Pregalvanised For 4x single Mosaic WCDs Available empty and pre-wired
			1	84060 77	Empty
			1	84060 77	Prewired Earthed Mosaic outlet

# Solflex Cable Floor System

H = 90 mm (continued)



# Solflex Cable Floor System

## mounting drawings

H = 90 mm



84000 10



84090 00

Verp. Ref.nr. **Outlet units** (continued)

### Support frame for keystone connectoren

Plastic  
To be used in combination with:  
- substructure universal ref.no. 84060 50  
- lower box data ref.no. 84060 74

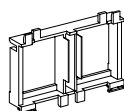

- 1 81905 00 Red
- 1 81905 01 Transparent
- 1 81905 02 Black
- 1 81905 03 Yellow
- 1 81905 04 Green
- 1 81905 06 Orange
- 1 81905 08 Brown

see overview page 28

### Built-in tile square

Pregalvanised  
Square 450 mm  
For lid & frame assembly square  
ref.no. 84532 02 or 84538 52  
Including wooden disposable cover

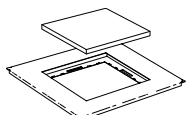

- 1 84090 51

### Lid & frame assembly square

Plastic with carpet edge  
Combine with mounting  
plate M45 large, and mounting box large

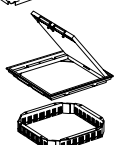

- 1 84538 52

### Built-in tile rectangular

Pregalvanised  
Rectangular  
For built-in cover rectangular  
ref.no. 84538 51

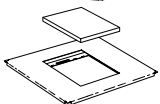

- 1 84090 61

### Lid & frame assembly rectangular

Plastic with carpet edge  
Combine with guard small and  
mounting plate M45 threefold

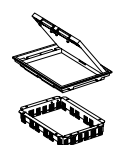

- 1 84538 51

### Built-in tile round

Pregalvanised  
Square 450 mm  
For lid & frame assembly round  
ref.no. 84548 53

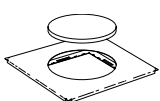

- 1 84090 71

### Lid & frame assembly round

Aluminium with carpet edge  
Combine with guard large and  
mounting plate M45 fourfold



- 1 84548 53

### Mounting box small

Plastic  
For lid & frame assembly rectangular

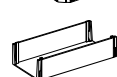

- 1 84550 01

### Mounting plate M45 small

Plastic  
For 7 modules Mosaic



- 1 84550 31

### Mounting box large

Plastic  
For round and square lid & frame  
assemblies

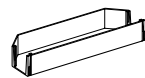

- 1 84550 02

### Mounting plate M45 large

Plastic  
For 9 modules Mosaic



- 1 84550 32

### Strain relief

Plastic



- 1 84550 06

### ■ Mounting drawing 1

Mounting of colonnette using  
surface-mounted tile and  
fixing bracket

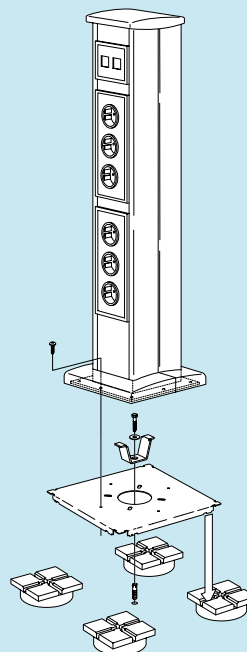

### ■ Mounting drawing 2

Positioning of the junction box

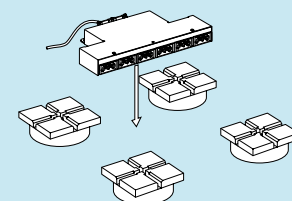

### ■ Mounting drawing 3

Mounting of lid & frame  
assembly in combination with  
built-in tile

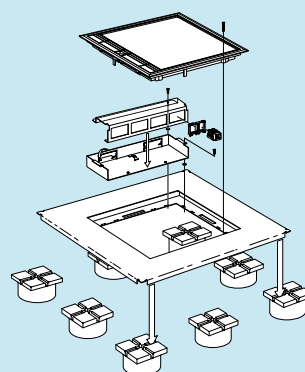

### ■ Mounting drawing 4

Mounting of lid & frame  
assembly in combination with  
built-in tile

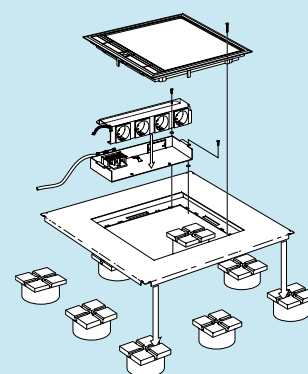

### ■ Mounting drawing 5

Mounting of lid & frame  
assembly in combination with  
built-in tile

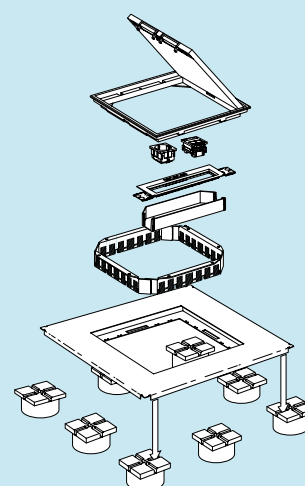

# Soluflex Cable Floor System

H = 120 mm

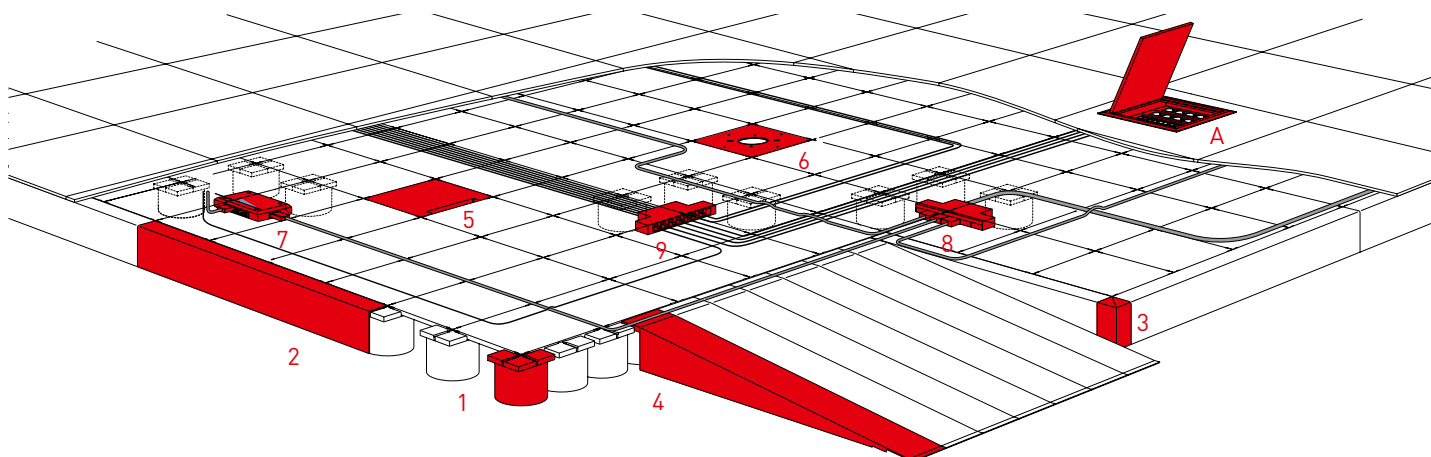

Verp.	Ref.nr.	Floor parts	
		<b>Tile</b>	
1	84000 10	Pregalvanised Square 225 mm H = 13 mm Provided with 4 contact/distance cams	
		<b>Support 1</b>	
1	84120 00	Black, polypropylene Square 100 mm With 2 square grooves in which tiles can be positioned	
		<b>Project edge finishing</b>	
1	84000 60	Pregalvanised L = 900 mm, B = 300 mm 2x turned edge of 13 mm Saw to size on-site for connections on the wall	
		<b>Edge finishing</b>	
1	84000 61	Pregalvanised L = 900 mm, B = 300 mm 1x turned edge of 13 mm Saw to size on-site for connections on the wall	
		<b>Plenum sealing 2</b>	
1	84120 20	Pregalvanised For sealing the floor in the free space H = 120 mm, L = 900 mm, B = 56 mm	
		<b>Plenum exterior angle 3</b>	
1	84120 30	Pregalvanised 56 x 56 mm	
		<b>Ramp 4</b>	
1	84120 40	Pregalvanised Ramp 10% L = 1181 mm, B = 112 mm Include 1 extra support ref.no. 84120 00 per ramp	
		<b>Earthing tile</b>	
1	84000 20	Pregalvanised, square 225 mm H = 13 mm Earthing clamp 6 mm² (max.) 1 tile per 100 m² or in gangways max. 14 metres apart, provided with 4 contact/distance projections	
		<b>Cable outlet tile 5</b>	
1	84000 30	Pregalvanised Square 225 mm H = 13 mm Recess 125 x 15 mm For lead-through to the workplace Provided with 4 contact/distance projections	
		<b>Lead outlet</b>	
1	81902 32	Chromed Apply with surface-mounted tile ref.no. 84000 40 For lead-through to the workplace	

Verp.	Ref.nr.	Floor parts (continued)	
		<b>Outlet/mounting tile 6</b>	
1	84000 40	Pregalvanised For colonnettes, pedestals + cable worm (see chapter power poles) and lead outlet (ref.no. 81902 32) Square 225 mm H = 13 mm Provided with 4 contact/distance projections	
		<b>Fixing bracket</b>	
1	84000 50	Pregalvanised For mounting colonnette (see chapter on power poles) onto the constructional floor with surface-mounted tile ref.no. 84000 40	
		<b>Outlet units</b>	
		<b>Junction box 6 V 7</b>	
1	81905 09	Plastic (black) 1 input GST 18, 1 output GST 18 Pre-wired with 6 branchings GST 18	
		<b>Junction box 6 V 8</b>	
1	84000 77	Pregalvanised 1 input YMVK, 1 output YMVK or lead Pre-wired with 6 branchings Fast Connector and provided with connection terminal with strain relief	
		<b>Junction box 6 V 9</b>	
1	84000 70	Empty	
		<b>Junction box data 8 V 9</b>	
1	84000 71	Recess for RJ 45 connector	
		<b>Built-in tile square</b>	
1	84090 51	Pregalvanised Square 450 mm For lid & frame assembly square ref.no. 84532 02 or 84538 52 Including wooden disposable cover	
		<b>Plastic lid assembly square A</b>	
1	84532 02	Plastic with carpet edge Combine with ref.no. 84090 51 and 84060 74 and/or 84060 69, 84060 80	
		<b>Lower box data</b>	
1	84060 74	Pregalvanised 4 double building in data Depending on R5 connector to be used with data support frame	
		<b>Lower box 230 V</b>	
		Pregalvanised For 4x single Mosaic WCDs Available empty and pre-wired	
1	84060 69	Empty	
1	84060 77	Prewired Earthed Mosaic outlet	



# Solflex Cable Floor System

H = 120 mm (continued)



# Solflex Cable Floor System

## mounting drawings

H = 120 mm



84000 10



84120 00

Verp.	Ref.nr.	Outlet units (continued)	
		<b>Support frame for keystone connectoren</b>	
		Plastic To be used in combination with: - substructure universal ref.no. 84060 50 - lower box data ref.no. 84060 74	
1	81905 00	Red	
1	81905 01	Transparent	
1	81905 02	Black	
1	81905 03	Yellow	
1	81905 04	Green	
1	81905 06	Orange	
1	81905 08	Brown see overview page 28	
		<b>Built-in tile square</b>	
1	84090 51	Pregalvanised Square 450 mm For lid & frame assembly square ref.no. 84532 02 or 84538 52 Including wooden disposable cover	
		<b>Lid &amp; frame assembly square</b>	
1	84538 52	Plastic with carpet edge Combine with mounting plate M45 large, and mounting box large	
		<b>Built-in tile rectangular</b>	
1	84090 61	Pregalvanised Rectangular For built-in cover rectangular ref.no. 84538 51	
		<b>Lid &amp; frame assembly rectangular</b>	
1	84538 51	Plastic with carpet edge Combine with guard small and mounting plate M45 threefold	
		<b>Built-in tile round</b>	
1	84090 71	Pregalvanised Square 450 mm For lid & frame assembly round ref.no. 84548 53	
		<b>Lid &amp; frame assembly round</b>	
1	84548 53	Aluminium with carpet edge Combine with guard large and mounting plate M45 fourfold	
		<b>Mounting box small</b>	
1	84550 01	Plastic For lid & frame assembly rectangular	
		<b>Mounting plate M45 small</b>	
1	84550 31	Plastic For 7 modules Mosaic	
		<b>Mounting box large</b>	
1	84550 02	Plastic For round and square lid & frame assemblies	
		<b>Mounting plate M45 large</b>	
1	84550 32	Plastic For 9 modules Mosaic	
		<b>Strain relief</b>	
1	84550 06	Plastic	

### ■ Mounting drawing 1

Mounting of colonnette using surface-mounted tile and fixing bracket

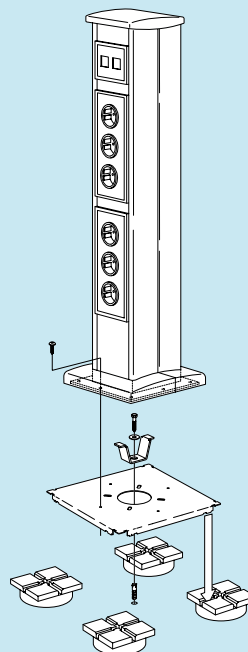

### ■ Mounting drawing 2

Positioning of the junction box

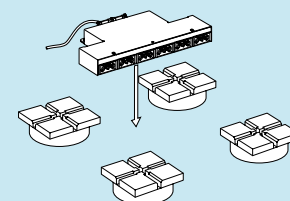

### ■ Mounting drawing 3

Mounting of lid & frame assembly in combination with built-in tile

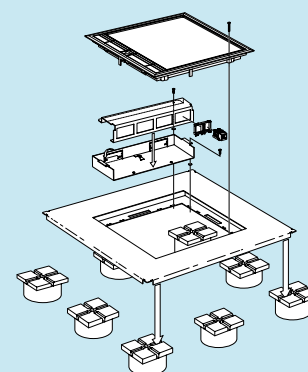

### ■ Mounting drawing 4

Mounting of lid & frame assembly in combination with built-in tile

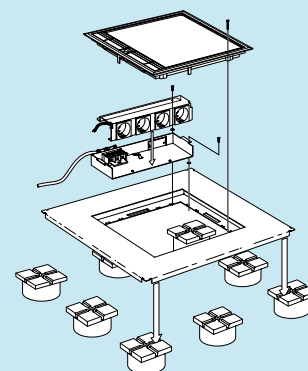

### ■ Mounting drawing 5

Mounting of lid & frame assembly in combination with built-in tile

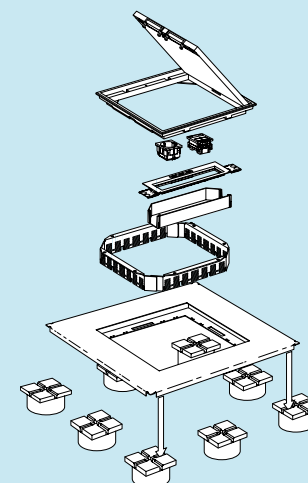



**Soluflex, the clever floor system**

# Soluflex® Cable Floor System dimensions

H = 37 mm

## ■ Dimensions

### Tile

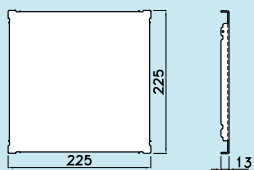

### Support

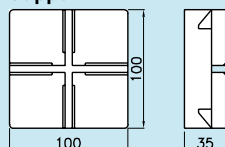

### Project edge finishing

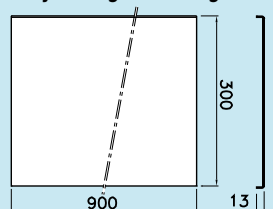

### Edge finishing

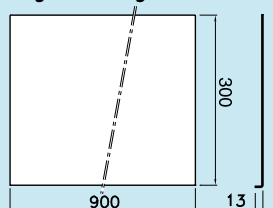

### Plenum sealing

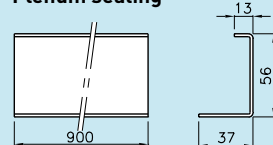

### Plenum exterior angle

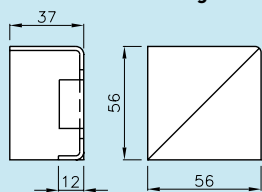

### Ramp

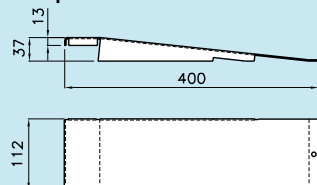

### Earthing tile

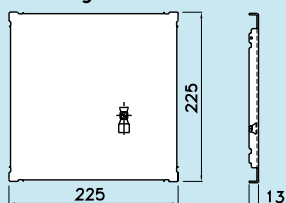

### Cable outlet tile

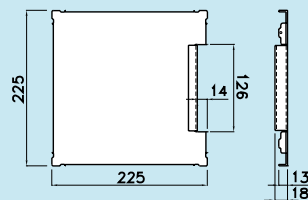

### Lead outlet

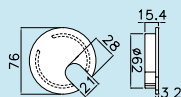

### Surface-mounting tile

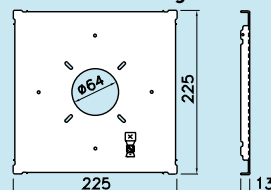

### Fixing bracket

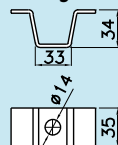

### Junction box 6 V

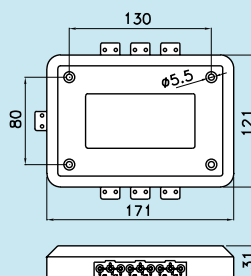

### Junction box 6 V

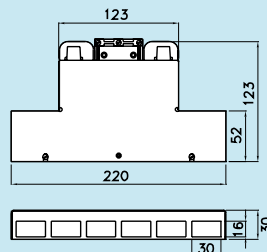

### Built-in square 45

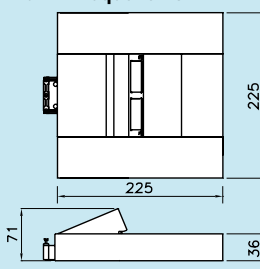

# Soluflex® Cable Floor System dimensions

H = 60 mm

## ■ Dimensions

### Tile

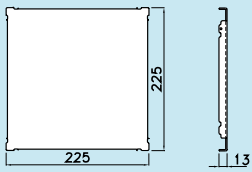

### Support

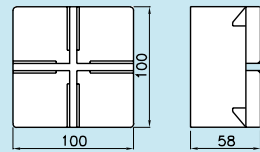

### Project edge finishing

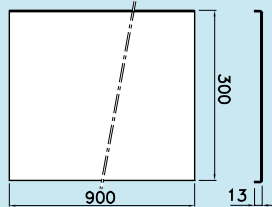

### Edge finishing

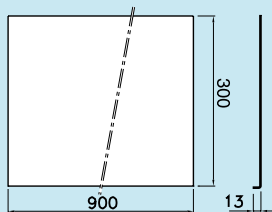

### Plenum sealing

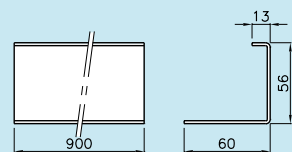

### Plenum exterior angle

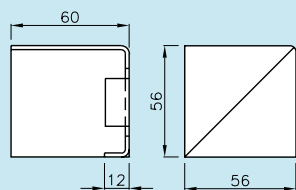

### Ramp

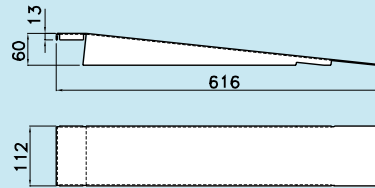

### Earthing tile

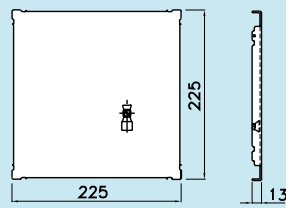

### Cable outlet tile

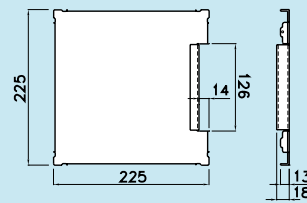

### Lead outlet

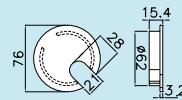

### Surface-mounting tile

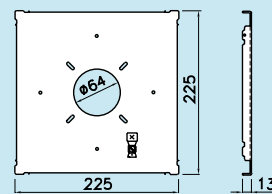

### Fixing bracket

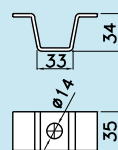

**Junction box 6 V**

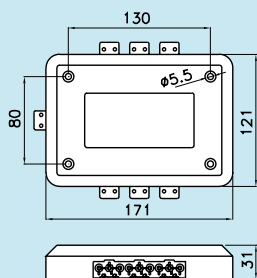

**Junction box 6 V**

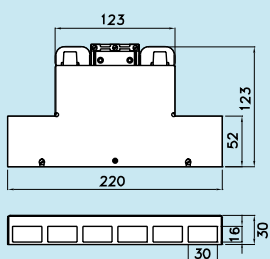

**Fully submerged unit square 45 2x 230 V (empty)**

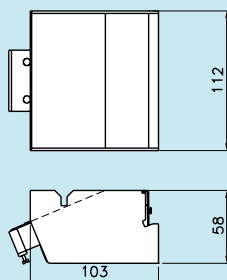

**Fully submerged unit square 45 2x 230 V (pre-wired)**

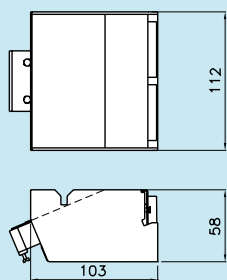

**Fully submerged unit square 45 data**

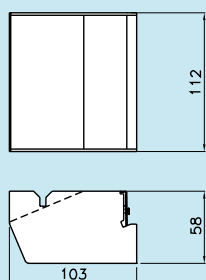

**Fully submerged unit universal**

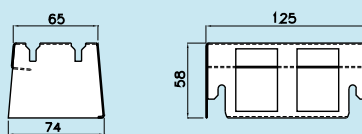

**Built-in tile square**

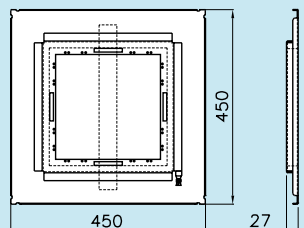

**Plastic lid & frame assembly square**

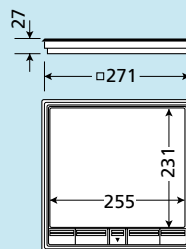

**Lower box data**

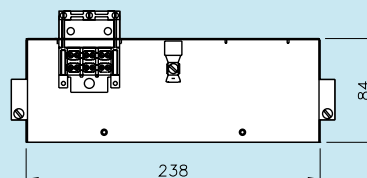

**Lower box 230 V**

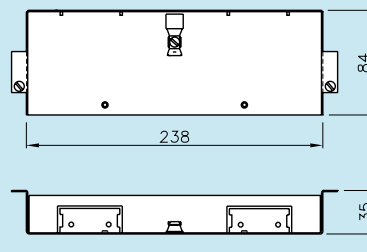

# Soluflex® Cable Floor System dimensions

H = 90 mm

## ■ Dimensions

### Tile

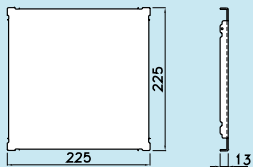

### Support

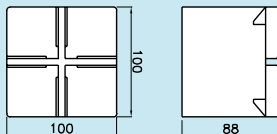

### Project edge finishing

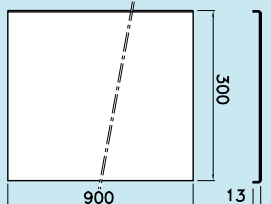

### Edge finishing

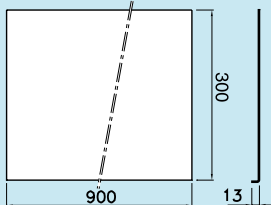

### Plenum sealing



### Plenum exterior angle

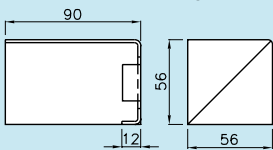

### Ramp

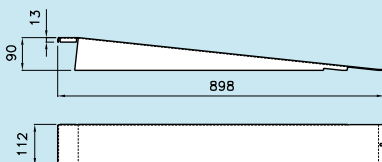

### Earthing tile

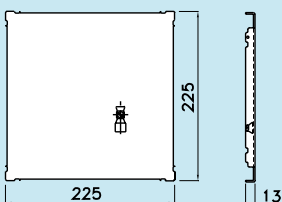

### Cable outlet tile

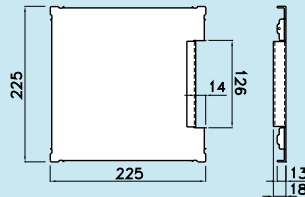

### Lead outlet

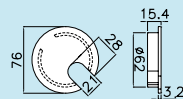

### Surface-mounting tile

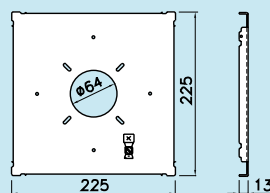

### Fixing bracket

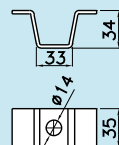

### Junction box 6 V

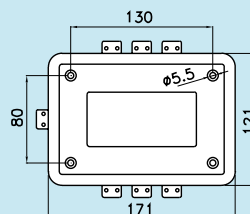

### Junction box 6 V

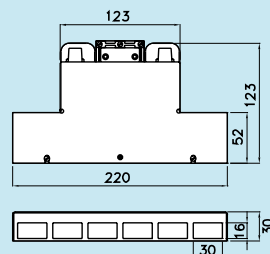

**Built-in tile square**

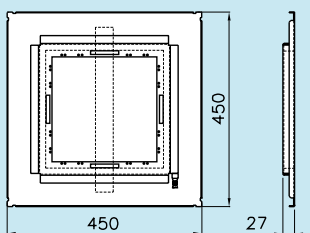

**Plastic lid assembly square for Soluflex H = 60 mm**

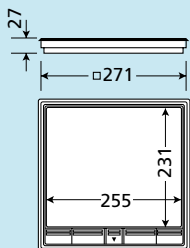

**Lower box data**

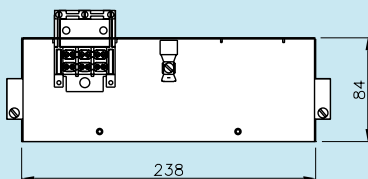

**Lower box 230 V**

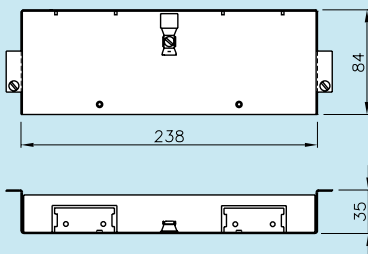

**Lid & frame assembly square for Soluflex H = 90 mm**

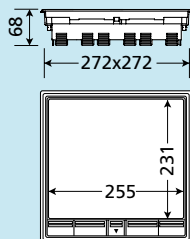

**Built-in tile rectangular**

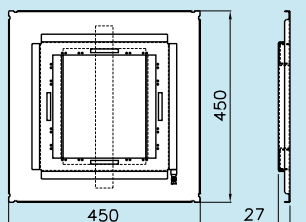

**Lid & frame assembly rectangular**

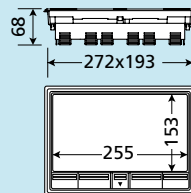

**Built-in tile round**

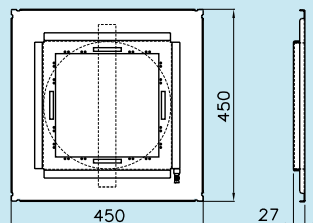

**Lid & frame assembly round**

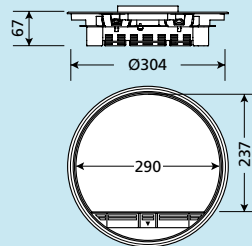

**Mounting box small**

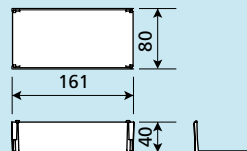

**Mounting plate M45 small (7 modules)**

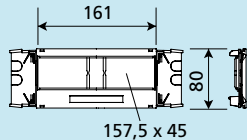

**Mounting box large**

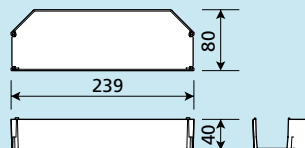

**Mounting plate M45 large (9 modules)**

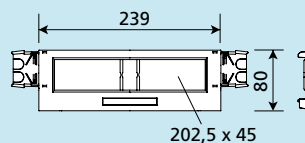

# Soluflex® Cable Floor System dimensions

H = 120 mm

## ■ Dimensions

### Tile

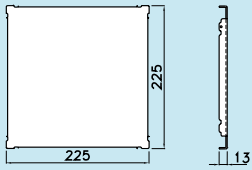

### Support

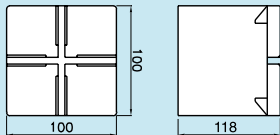

### Project edge finishing

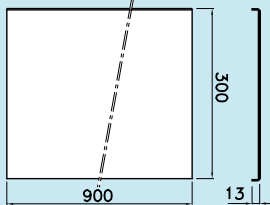

### Edge finishing

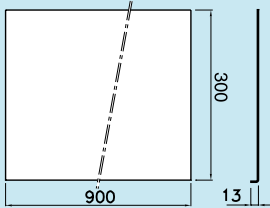

### Plenum sealing

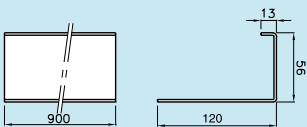

### Plenum exterior angle

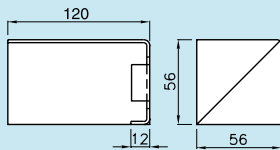

### Ramp

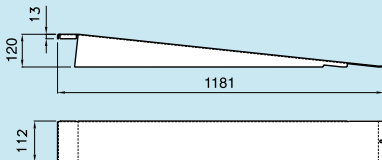

### Earthing tile

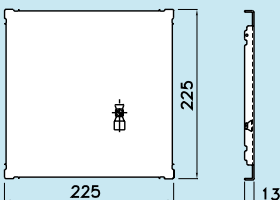

### Cable outlet tile

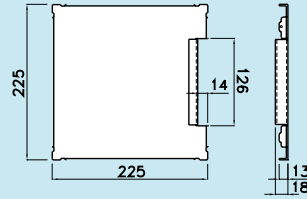

### Lead outlet

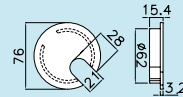

### Surface-mounting tile

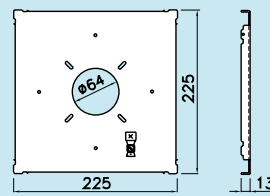

### Fixing bracket

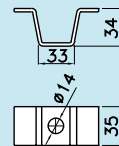

### Junction box 6 V

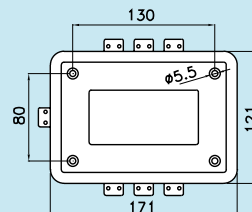

### Junction box 6 V

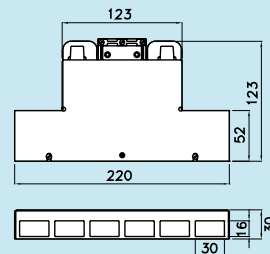



**Built-in tile square**

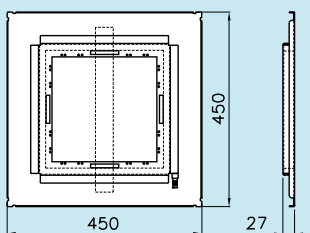

**Plastic lid assembly square for Soluflex H = 60 mm**

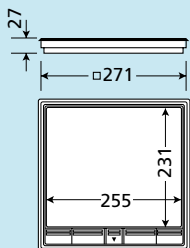

**Lower box data**

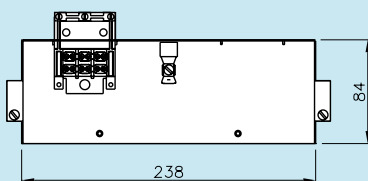

**Lower box 230 V**

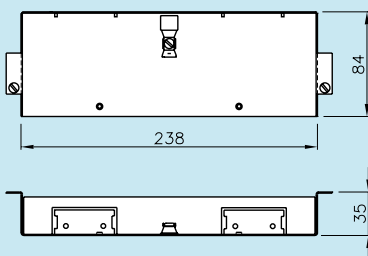

**Lid & frame assembly square for Soluflex H = 90 mm**

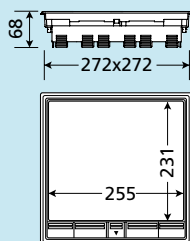

**Built-in tile rectangular**

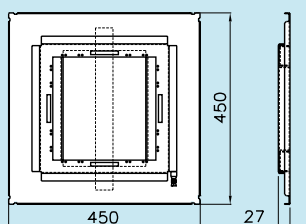

**Lid & frame assembly rectangular**

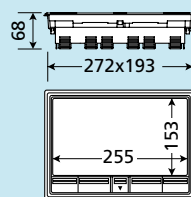

**Built-in tile round**

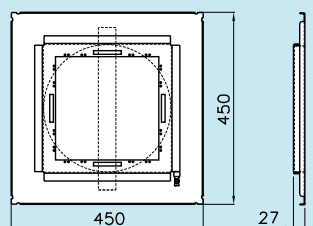

**Lid & frame assembly round**

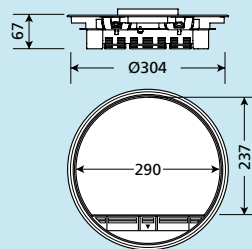

**Mounting box small**

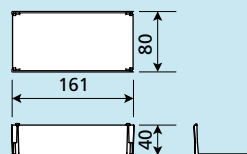

**Mounting plate M45 small (7 modules)**

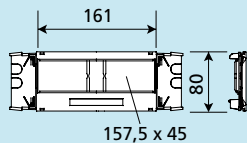

**Mounting box large**

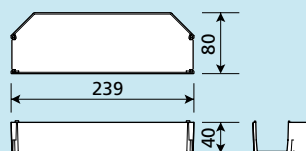

**Mounting plate M45 large (9 modules)**

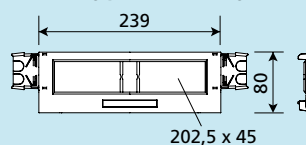

# Soluflex Cable Floor System mounting instruction

H = 37 mm, 60 mm, 90 mm, 120 mm

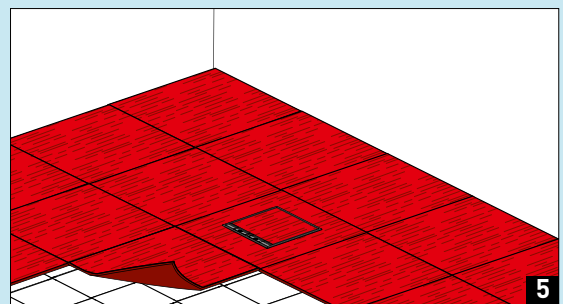
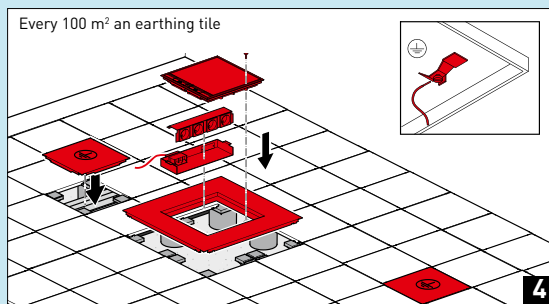
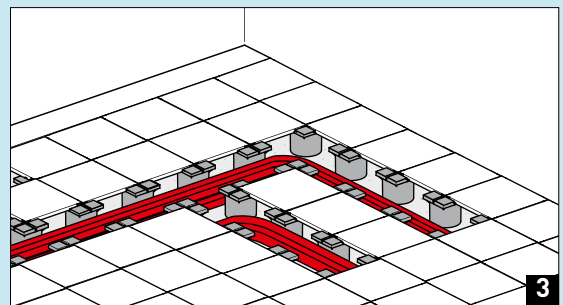
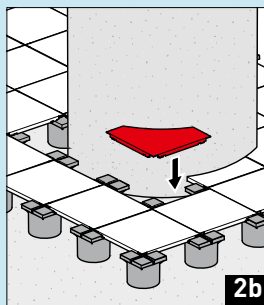
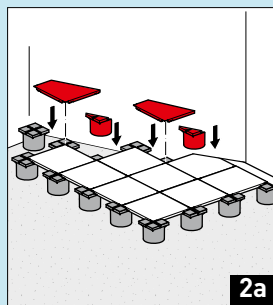
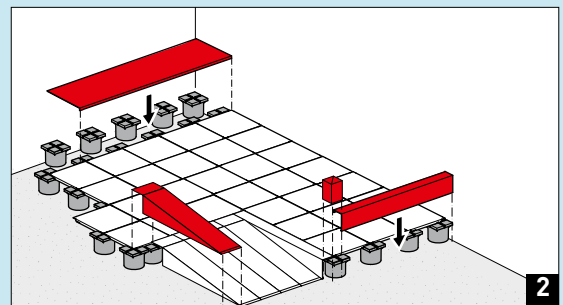
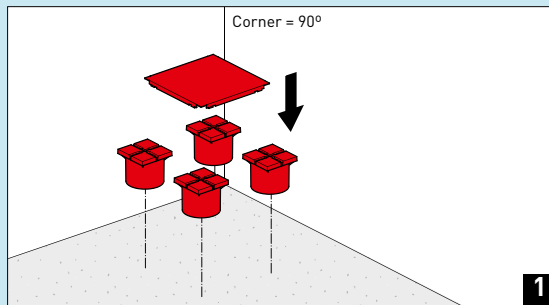
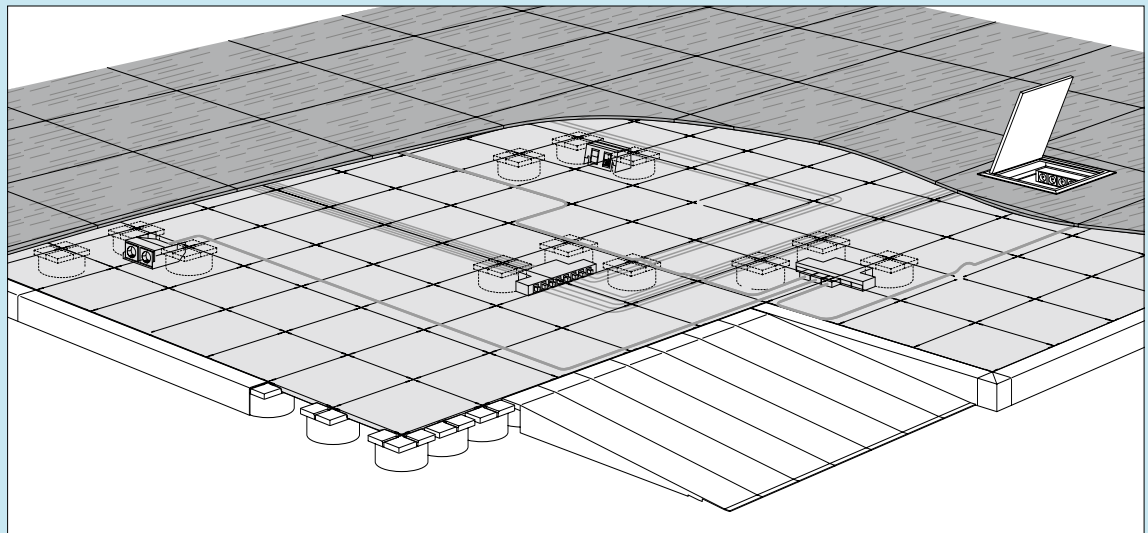
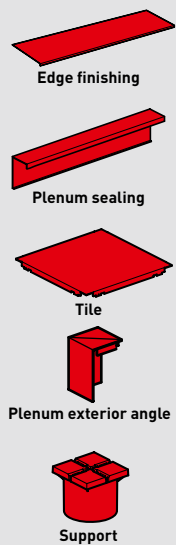

## Installation instructions:

1. Start in a room with a dry, clean and level subfloor from a square corner and click the tiles into the plastic supports
2. Cut fitting tiles or edge finishing to size
3. You are now ready for opening the cable routes using a cabling plan  
The corners of the tiles have small recesses for lifting them up using, for example, a screwdriver. Remove the other tile by hand
4. Earthen the cable floor system every 100 m<sup>2</sup> by means of an earthing tile
5. The Soluflex cable floor system can be finished with e.g. carpet tiles



# Soluflex Cable Floor System mounting instruction earthing tile

H = 37 mm, 60 mm, 90 mm, 120 mm

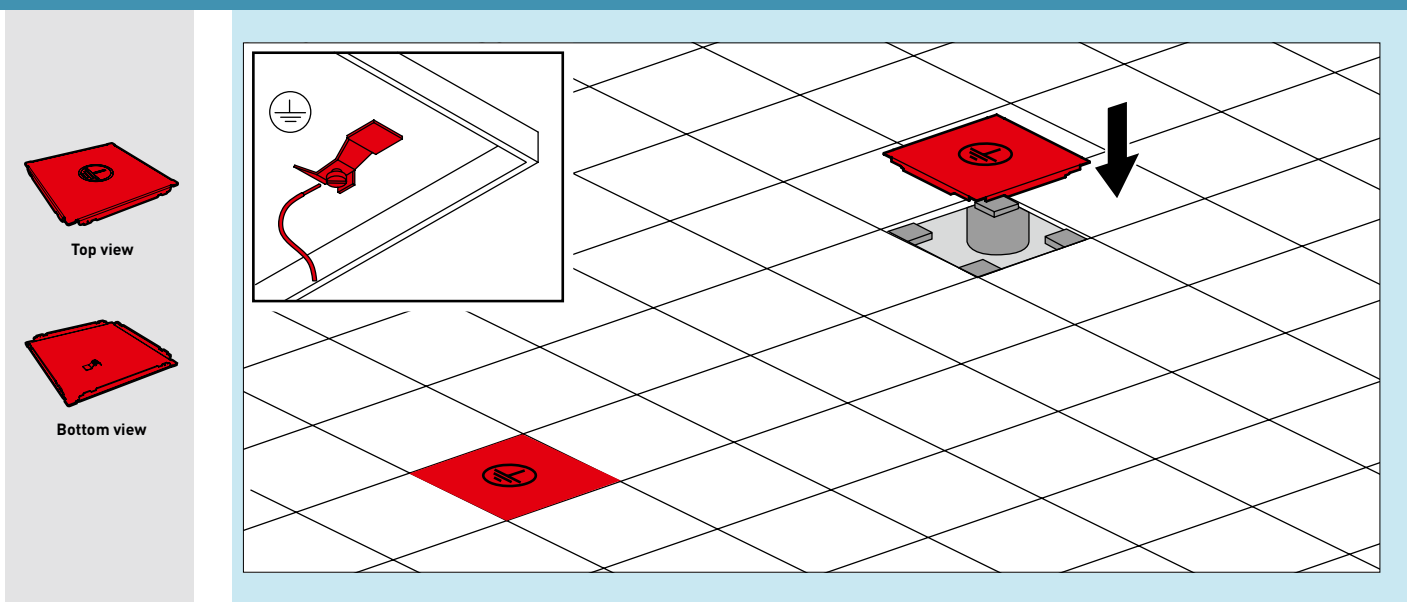

## Using an earthing tile on a Soluflex floor



- Dimensions: 225 x 225 x 13 mm.
- 4 contact/spacer ridges and an earth connection suitable for 4 to 6 mm<sup>2</sup>.
- Every metal unearthed floor element must be within a distance of 7 metres, (i.e. 1 earthing tile per 100 m<sup>2</sup>).
- Please contact the technical engineer for the correct location of the earthing tiles.

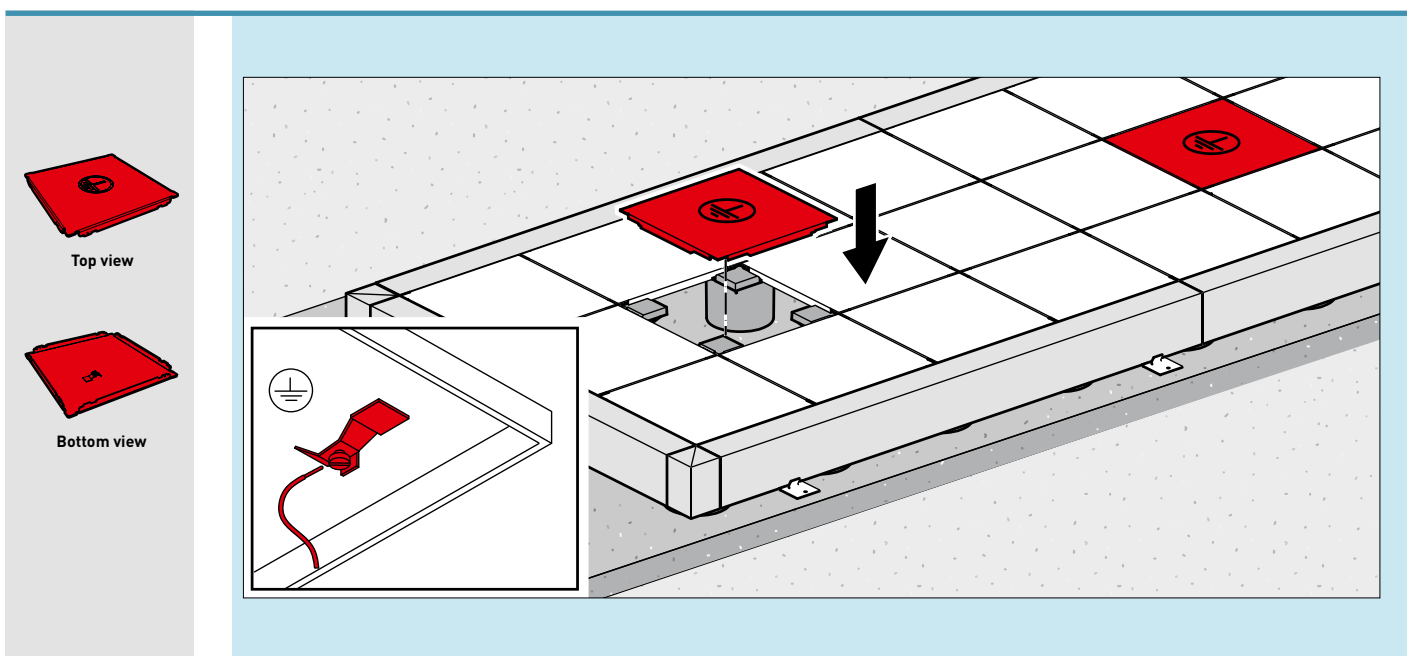

## Using an earthing tile on a Soluflex service channel



- Dimensions: 225 x 225 x 13 mm.
- 4 contact/spacer ridges and an earth connection suitable for 4 to 6 mm<sup>2</sup>.
- Every metal unearthed floor element must be within a distance of 7 metres.
- Please contact the technical engineer for the correct location of the earthing tiles.

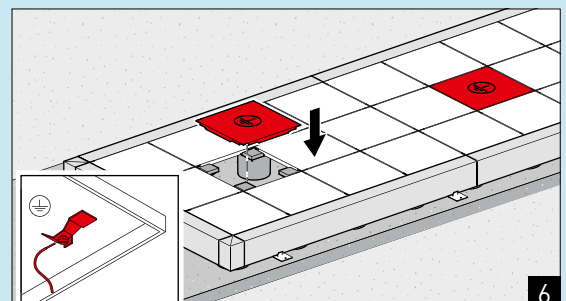
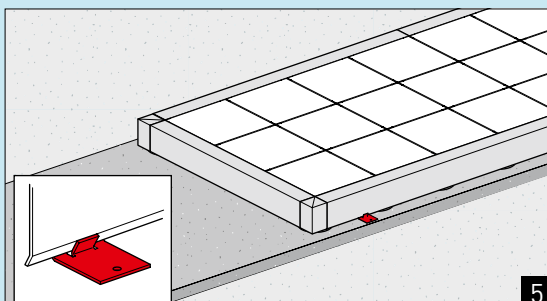
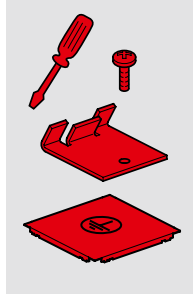
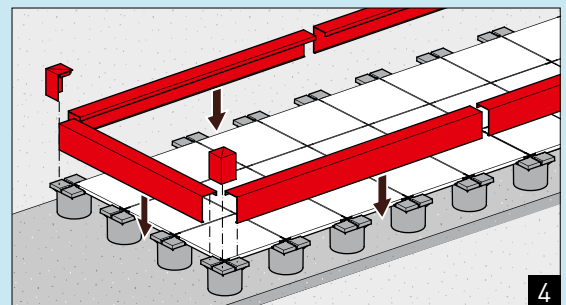
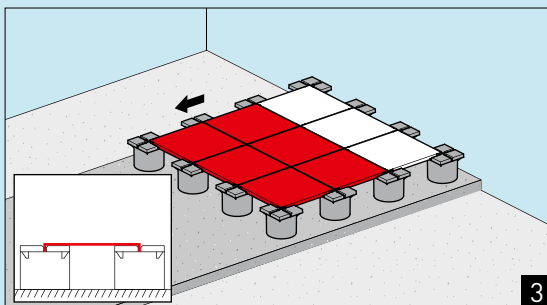
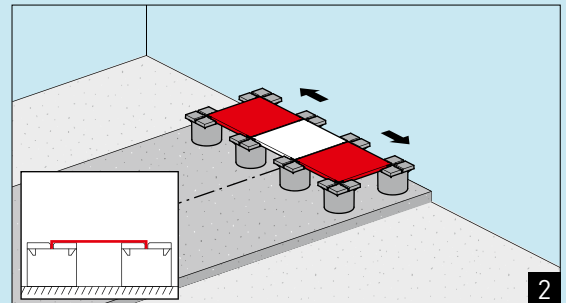
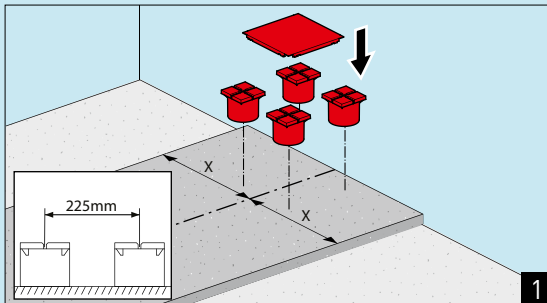
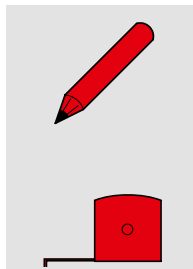
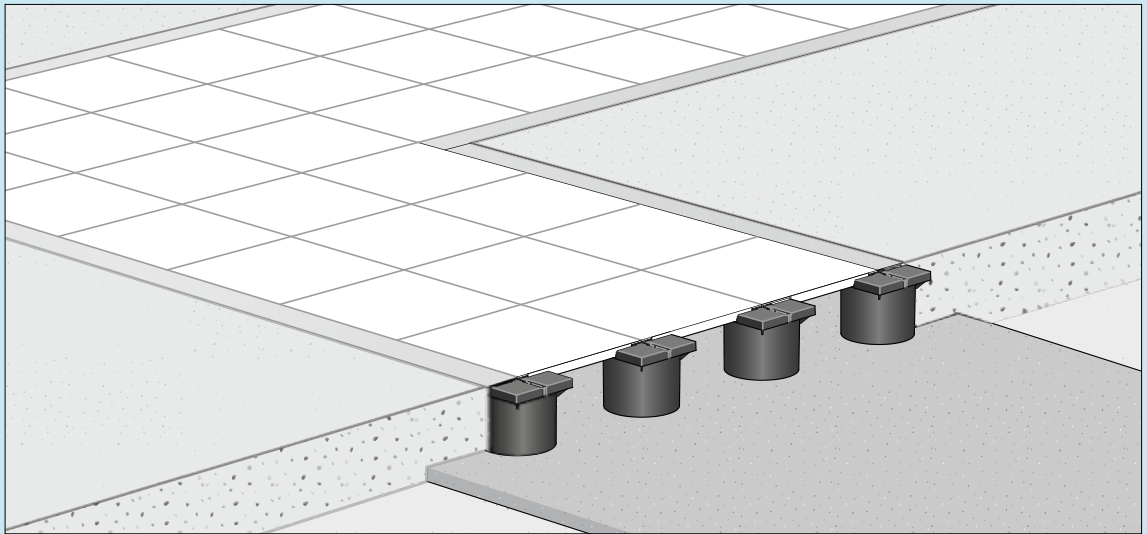
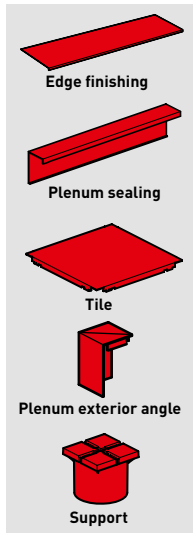

## Assembly

- Place the Soluflex service channel on a dry, clean and even floor area. Equalize the floor area according to the applicable building regulations. Contact a flooring expert if necessary. A reference sheet is available on request.
- Use fastening clamps, when needed, to make the fitting of the channel more secure (5). The number of clamps needed depends on the length and width of the channel. If you are unsure about this then contact your supplier.
- The use of grounding tiles is compulsory (6). The maximum distance between the tiles is 14 m. Contact the technician about the correct placing.

# Soluflex Cable Floor System mounting instruction service channel

H = 37 mm, 60 mm, 90 mm, 120 mm

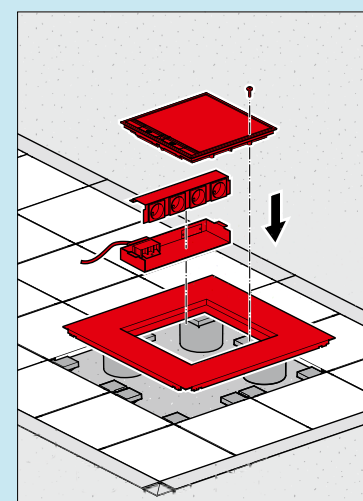
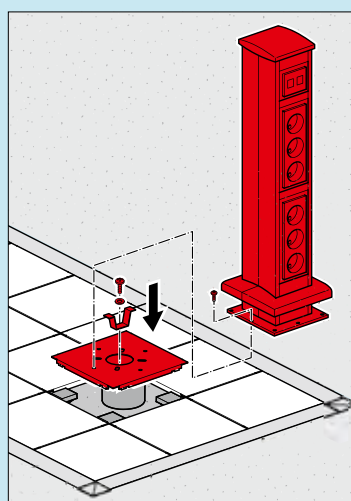
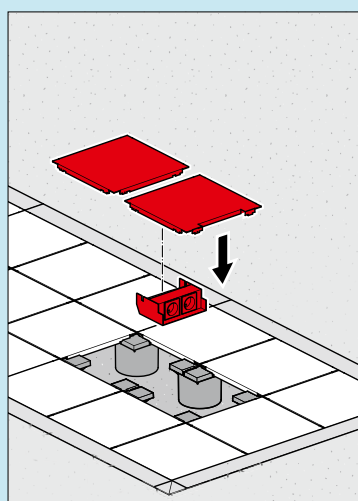
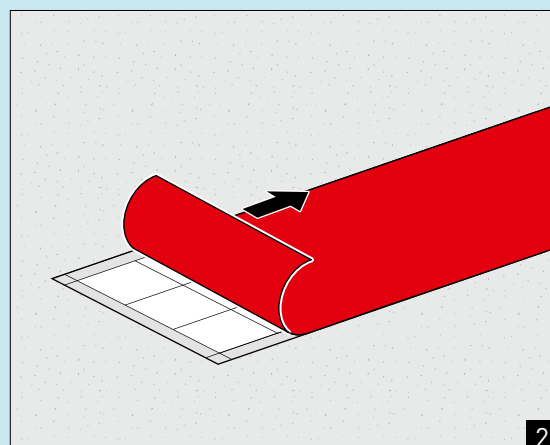
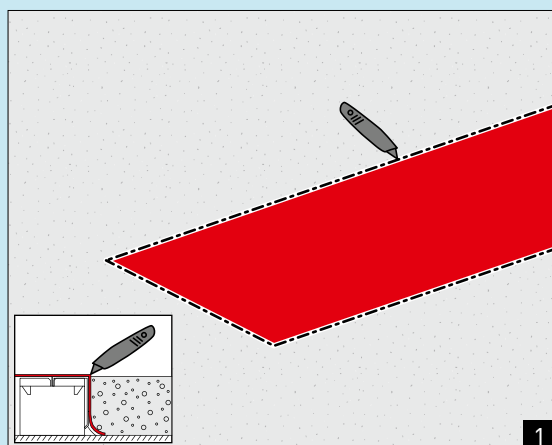
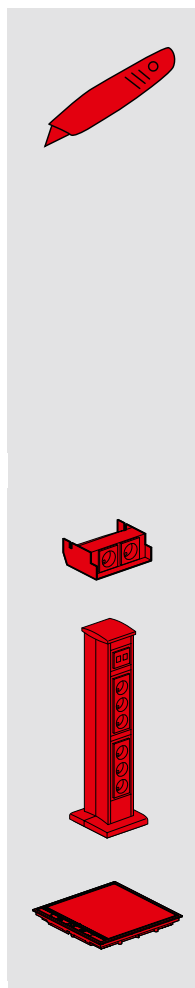
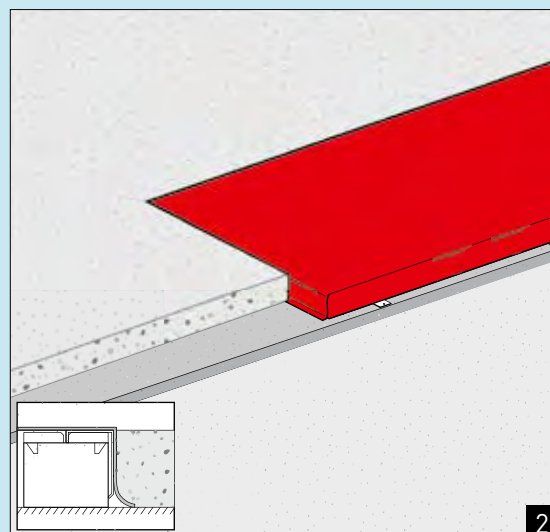
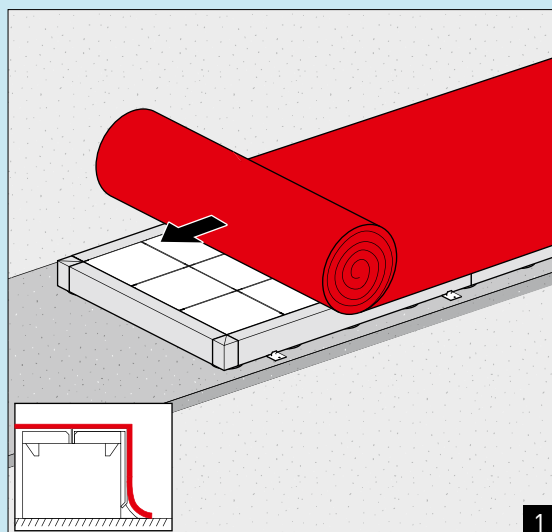
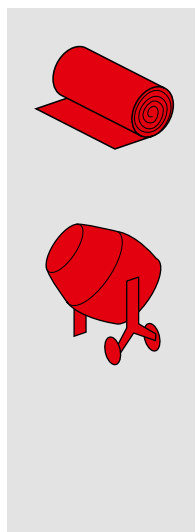

### Finishing

- Cover up the channel entirely after assembly. Use only materials that are suitable for building. A list of materials is available on request.
- Before putting on the floor covering, contact a flooring expert. A reference sheet is available on request.

### In use

- Remove the covering material, the service channel is now ready to use. Contact a technician if necessary.







**Legrand Nederland BV**

P.O. Box 54  
5280 AB Boxtel  
The Netherlands

T +31 (0)411 65 31 11  
F +31 (0)411 68 28 95  
E [info@legrandnederland.nl](mailto:info@legrandnederland.nl)  
I [www.legrandnederland.nl](http://www.legrandnederland.nl)