



DATA CENTER

TECHNOLOGY SOLUTIONS

POWER DISTRIBUTION

- Intelligent PDUs
- Inline Meters
- Locking Cables
- Environmental Sensors
- Transfer Switches
- Branch Circuit Monitor
- DCIM Software

RACK MANAGEMENT

- Secure Door Handles
- Smart Rack Controller
- Rack Environment Sensors
- Asset Management

ACCESS & CONTROL

- KVM-over-IP Switches
- KVM-over-IP (4K Video)
- Secure Switch
- Serial Consoles
- Analog Cat5 KVM
- Console Drawers



WE'RE ALL ABOUT INNOVATION

The Raritan brand is synonymous with innovation in data center power distribution and management solutions, serial consoles, and KVM-over-IP switching technology.

In over 76 countries worldwide, Raritan's award-winning solutions increase energy efficiency, improve reliability, and raise productivity.

Visit www.raritan.eu for more information.

TABLE OF CONTENTS

PROFILE	02
POWER DISTRIBUTION	
Intelligent PDUs	04
Inline Meters	05
Locking Cables	06
Environmental Sensors	06
Transfer Switches	07
Branch Circuit Monitor	08
DCIM Software	09
RACK MANAGEMENT	
Secure Door Handles	10
Smart Rack Controllers	12
Rack Environment Sensors	12
Asset Management	14
ACCESS & CONTROL	
Centralized Infrastructure Management	17
KVM-over-IP Switches	18
KVM User Stations	19
Computer Interface Modules	19
KVM-over-IP (4K Video)	21
Secure Switch	21
Serial Consoles	22
Analog Cat5 KVM	24
Console Drawers	24
Accessories	24



ABOUT RARITAN

A proven innovator of intelligent power distribution, rack management, serial consoles, and KVM-over-IP switches for data centers of all sizes. In over 60,000 locations worldwide, Raritan’s award-winning solutions increase energy efficiency, improve reliability, and raise productivity, whilst reducing operational cost.

Raritan was founded in 1985 in Somerset, NJ (USA) and acquired by Legrand in 2015. Today, Legrand - *powered by experts* - from Minkels, Raritan, and Starline offer scalable, best-in-class data center solutions worldwide.

GLOBAL PARTNER NETWORK

Raritan is represented in 76 countries with a partner network spanning the globe.

Users can rely on best-in-class hardware and software solutions supported by a team of highly skilled individuals, passionate to answer and resolve your technical product related questions.

VADs, VARs and System Integrators interested in selling Raritan products should contact marketing.europe@raritan.com.

When partnering with us, you’ll build a stream of revenue from an array of satisfied customers. In short, we help you to grow your business by solving your client’s biggest data center management challenges.

INNOVATION

Our solutions help IT professionals gain more insight into data center operations and manage smarter in more than one way. We help maximize uptime, optimize efficiency and allow for strategic decision-making based on reliable data points.

Raritan is always looking to push technology further and innovation is at our core. With 47 patents granted and 30 more applications pending, we make sure you always have the latest and future-proof technology.

TRUSTED

When you buy a Raritan product you can be sure you are getting a product that’s been manufactured with great care and to the highest standard.

Many of Raritan’s products have been awarded by the industry and for years are being relied upon 24/7/365 by thousands of customers worldwide.

CUSTOMER FOCUSED

At Raritan we believe customers should always come first, whether it’s in designing a new product or when we get a support question, Raritan makes sure the customer gets an effortless experience.



ENDORSER OF THE EU CODE OF CONDUCT ON DATA CENTER ENERGY EFFICIENCY

Formulated by the EU’s Joint Research Center, the Code is a measured response to the energy challenges the EU faces. It’s aim is to encourage companies with data centers to reduce energy consumption while ensuring business objectives continue to be met.

As an endorser, Raritan have pledged to implement the Code’s ethos through devising products and services that help organizations to bring their data centers into line with its best practice recommendations.

POWER DISTRIBUTION & RACK MANAGEMENT

POWER MANAGEMENT, MONITORING AND CONTROL

Raritan's power distribution and rack management solutions are your best choice in the data center and IT test labs. It's relied upon daily for applications such as co-location, Edge and IoT. What's more, it's natively compatible with all DCIM software solutions.

Also available from Raritan is a wide range of rack management solutions to help control, protect, and ensure uptime of your critical IT devices in the rack.

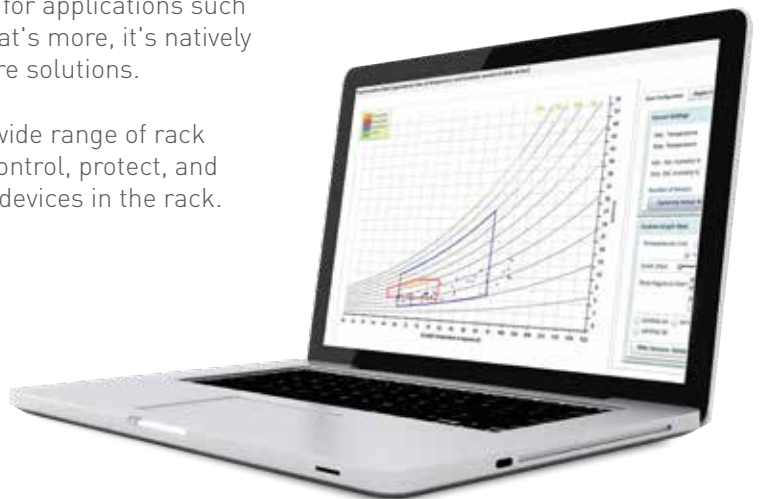

**"RARITAN PROVIDES CUSTOMERS THE
BEST SOLUTION FOR THEIR CHALLENGES"**

PX[®] - INTELLIGENT PDUS

The PX intelligent rack PDU series offers more than just power distribution - it's a launch pad for real-time remote power monitoring, environmental sensors, and data center infrastructure management. From the ground up, PX intelligent PDUs are architected with components, features, and failsafes that ensure the most reliable power infrastructure possible, both now and for years to come.

Choose from hundreds of models with features that include outlet switching, individual outlet (device) metering, high power, and 400V three-phase power distribution. You can have certain off-the-shelf models delivered in only a few days, or have PDUs purpose-built to meet the needs of your unique application.

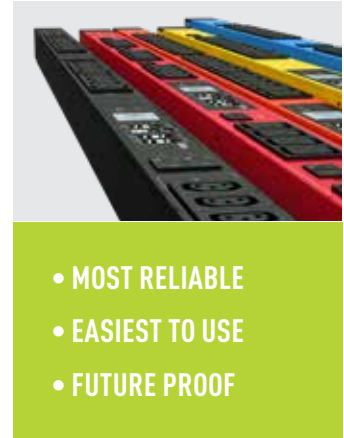

- MOST RELIABLE
- EASIEST TO USE
- FUTURE PROOF



"RARITAN'S POWER INTELLIGENCE CAPABILITIES AT THE DEVICE LEVEL PROVIDE IMPORTANT INSIGHTS ON HOW TO IMPROVE ENERGY EFFICIENCY IN DATA CENTERS AND OTHER LOCATIONS."

Jeff Reed, Vice President of Ethernet Switching Technology Group, Cisco

MOST RELIABLE

Rock Solid Uptime, No Compromises

KWH METERING ACCURACY	BUILT-IN FAILOVER POWER	CIRCUIT BREAKER TRIP ALARMING	RESIDUAL CURRENT MONITORING*	60°C (140°F) MAX TEMP



EASIEST TO USE

Simple to Deploy, Simple to Use.

COLOR MATRIX LCD DISPLAY	SLEEK AND INTUITIVE USER INTERFACE
ZERO TOUCH DEPLOYMENT	NETWORK CASCADING AND BUILT-IN WIRELESS

* RCM type A and B (single and three channel) available as an option on most models (legally required in a growing number of European countries).

FUTURE PROOF

Infrastructure That Will Never Be Obsolete.



HIGH POWER DENSITIES



MULTIPLE CONNECTIVITY
OPTIONS



GIGABIT ETHERNET



EXTENSIVE DCIM
INTEROPERABILITY

PX INTELLIGENT PDU FAMILIES

7.36 kVA



	1000 SERIES	2000 SERIES	4000 SERIES	5000 SERIES
Inlet Metering	■	■	■	■
Branch Circuit Metering	■	■	■	■
Circuit Breaker Alarming	■	■	■	■
Outlet Level Metering			■	■
Outlet Level Switching		■		■

To find your ideal PX intelligent PDU, visit www.findmypdu.com

INLINE METERS

The PX-3000 series inline power meters simplify management of power usage and environmental conditions in the data center while allowing you to monitor the power on dedicated circuits.

There is no need to remove or re-cable IT equipment. Just wire the inline meter into existing circuits and get real-time remote power monitoring, including current (amps), voltage (Volts), power (kVA, kW) and energy consumption (kWh) to +/- 1% accuracy. Plus they're sensor ready to support all Raritan environmental sensors.



SECURELOCK® CABLES



INTEGRATED LOCKING SYSTEM OF POWER CORDS AND RACK PDU OUTLETS

Prevent accidental power cord disconnects with SecureLock - an integrated locking system of power cords and rack PDU outlets which secures power cords to Raritan's PX rack PDUs. The PDUs are equipped with SecureLock outlets that work with standard power cords and lock when using these cords to prevent cables from coming unplugged.

SECURELOCK BENEFITS

- PREVENT ACCIDENTAL POWER CORD DISCONNECTS
- COLOR CODE YOUR POWER CHAINS
- MAINTAIN UPTIME IN HIGH-HEAT DATA CENTERS

Available in 5 different colors: black, red, blue, green, and white.

CABLE TYPES

- IEC C-14 (m) to IEC C-13 (f)
- IEC C-14 (m) to IEC C-15 (f)
- IEC C-20 (m) to IEC C-19 (f)

Available in a wide variety of cable lengths.

ENVIRONMENTAL SENSORS

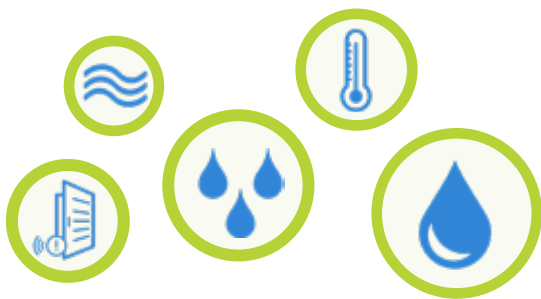

GRANULAR ENVIRONMENTAL MONITORING

Plug-and-play environmental sensors for temperature, humidity, airflow, differential air pressure, and leaks connect to a dedicated iPDU port. All sensors are built with field-replaceable heads, are daisy-chainable (up to 32 sensors), and alert you to potential threats that could cause downtime.



TRANSFER SWITCHES



RELIABLE POWER FOR SINGLE-CORDED DEVICES

Raritan hybrid rack transfer switch prevents downtime in racks with single power supply devices. It provides power metering at the inlet, outlet, and branch circuit level. It also offers outlet-level switching for better remote power control.

This switch cleverly uses both electromechanical relays and silicon-controlled rectifiers (SCRs) to maximize the positive and minimize the negative characteristics of both automatic and static transfer switches (ATS/STS).

PATENT-PENDING HYBRID DESIGN

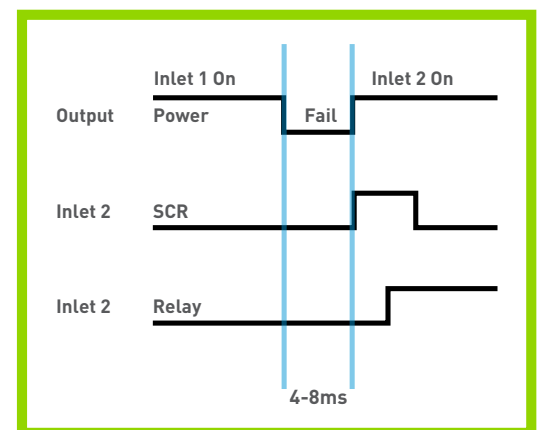

Hybrid (relay+SCR-based) Transfer Time



FEATURES AND BENEFITS

- Fast transfer load times (4 - 8ms)
- Reliable transfer between sources regardless of phase
- Over-sized relays (rated 48A) and SCRs (rated 70A)
- Eliminates electrical arcing that leads to relay failures
- Inlet surge protection and field replaceable, fast-blow fuses for short circuit protection
- Threshold alerting and status updates
- Logs transfer times for reporting
- SmartSensor™ support
- USB support

BRANCH CIRCUIT MONITOR



Raritan’s intelligent Branch Circuit Monitoring (BCM) system allows you to fully utilize your power infrastructure and manage capacity as your data center grows and changes. Whether you are retrofitting an existing facility, or planning for growth or new construction, Raritan’s BCM system can help you reduce energy costs, track power usage, and prevent downtime. Easily add metering where it never existed before.

This easy-to-deploy modular system, enables real-time views of electrical capacity and power usage on branch circuits, and mains, in an electrical service entrance or a remote power panel. It sends threshold alerts for power and environmental conditions, thereby helping to prevent downtime. The data can also support energy efficiency and customer charge-back initiatives.

FEATURES AND BENEFITS

- Meters Floor PDU, RPPs, Panelboards, and Busways
- One controller supports up to 70 power meters
- Current Transformers (CTs) connect to live circuits
- Auto-correct metering adjusts for CT orientation on wires
- Real-time configurator
- USB ports for configuration, Wi-Fi networking, and tablet display
- Several enclosure options
- Collects data on: A, V, kW, kVA, power factor, and kWh
- Protocols include TCP/IP, Modbus and SNMP

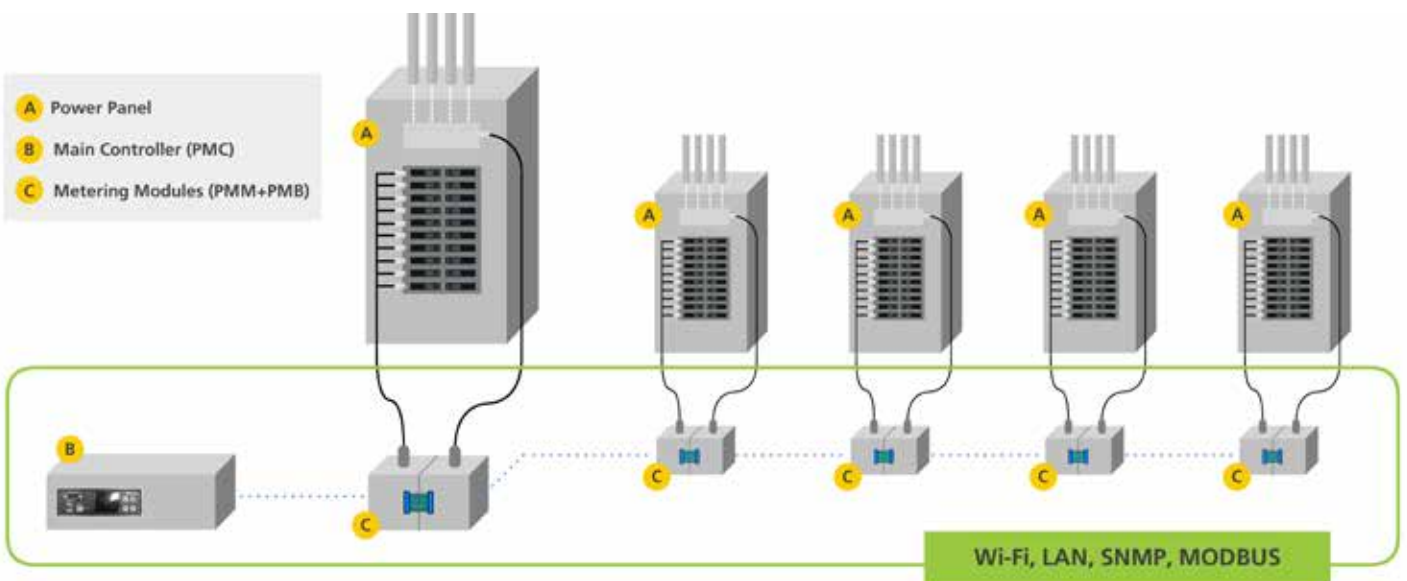

DCIM SOFTWARE



POWER IQ®

Power IQ enables data center and facility managers to maintain uptime and improve efficiency of power and cooling resource utilization.

The software automatically collects live power and environmental measured readings, listen for alarms, monitor thresholds, and send email alerts. It also improves people efficiency by providing a single pane of glass to all your intelligent racks PDUs and sensors. Plus, it enables you to perform bulk configuration and firmware update operations on your Raritan and ServerTech devices including automatically backing-up configurations to make it easy to restore a configuration to a single PDU or clone settings to many PDUs. The dashboard turns data in to information with health and capacity maps, live webcam video, power capacity analytics, trend charts, alarm lists, and ASHRAE cooling charts.

Power IQ, initially developed by Raritan and now offered to you by Sunbird Software Inc., fully integrates with Raritan, ServerTech, and Starline power management products.

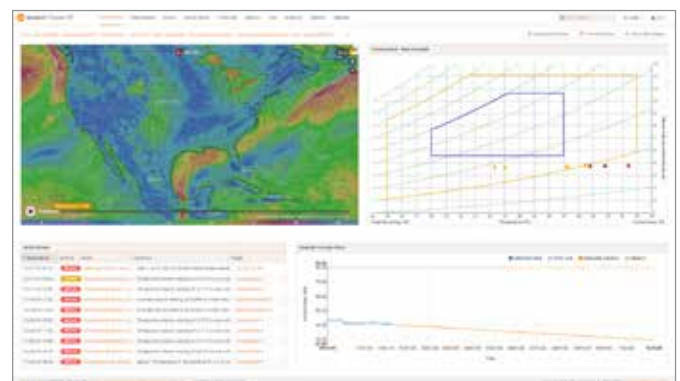

POWER IQ ALLOWS YOU TO:

- Mass update Raritan and ServerTech PDU configurations, firmware, and passwords
- Monitor and report on rack power redundancy
- Find ghost servers
- Eliminate stranded power capacity
- Instantly identify hot spots
- Know about incidents before they become problems

[Find out more on sunbirddcim.com](http://sunbirddcim.com)



SMARTLOCK® SECURE DOOR ACCESS CONTROL

SmartLock is a networked, electronic door access and control system designed to deliver audited controlled access to physical sensitive IT assets in the data centers' white space. This universal, vendor agnostic door access and control system will seamlessly integrate with your data center's technology architecture to:

- Simplify operations, while enabling enterprise-level security
- Automate physical access monitoring
- Reduce total deployment effort and cost

SCALABLE

An economic, scalable solution that addresses evolving security requirements for IT applications and regulatory compliance.

EASY TO DEPLOY / RETROFIT

Pre-configured for Raritan PX PDUs or door sensor, and with a universal formfactor to accommodate most cabinets, SmartLock allows for rapid deployment in new and retrofit datacenter projects.

SMART CARD COMPATIBLE

Compatible with 125kHz proximity cards and 13.56 MHz RFID cards including Legic®, my-d®, DESFire®, Tag-it®, Felica®, iClass®, MIFARE®, and I-Code® technologies for maximum security and to meet the most stringent SLA requirements.

DOOR HANDLE LOCKING TYPES BASED ON YOUR NEEDS



SmartLock Basic

Easy introduction to rack access control



SmartLock Standard

A perfect fit for enterprise security standards



SmartLock Advanced

Versatile and scalable access control

VIRTUAL CAGING

Users can lock or unlock individual or multiple racks based on configurable authorization and authentication permissions.

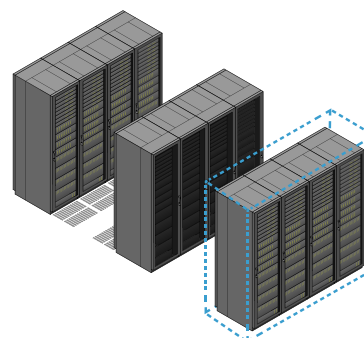

CABINET ACCESS CONTROL AND COMPLIANCE MADE EASY



ELECTRONIC DOOR HANDLE



INTELLIGENT DOOR SENSOR



PX INTELLIGENT RACK PDU



XERUS FIRMWARE



POWER IQ DCIM SOFTWARE

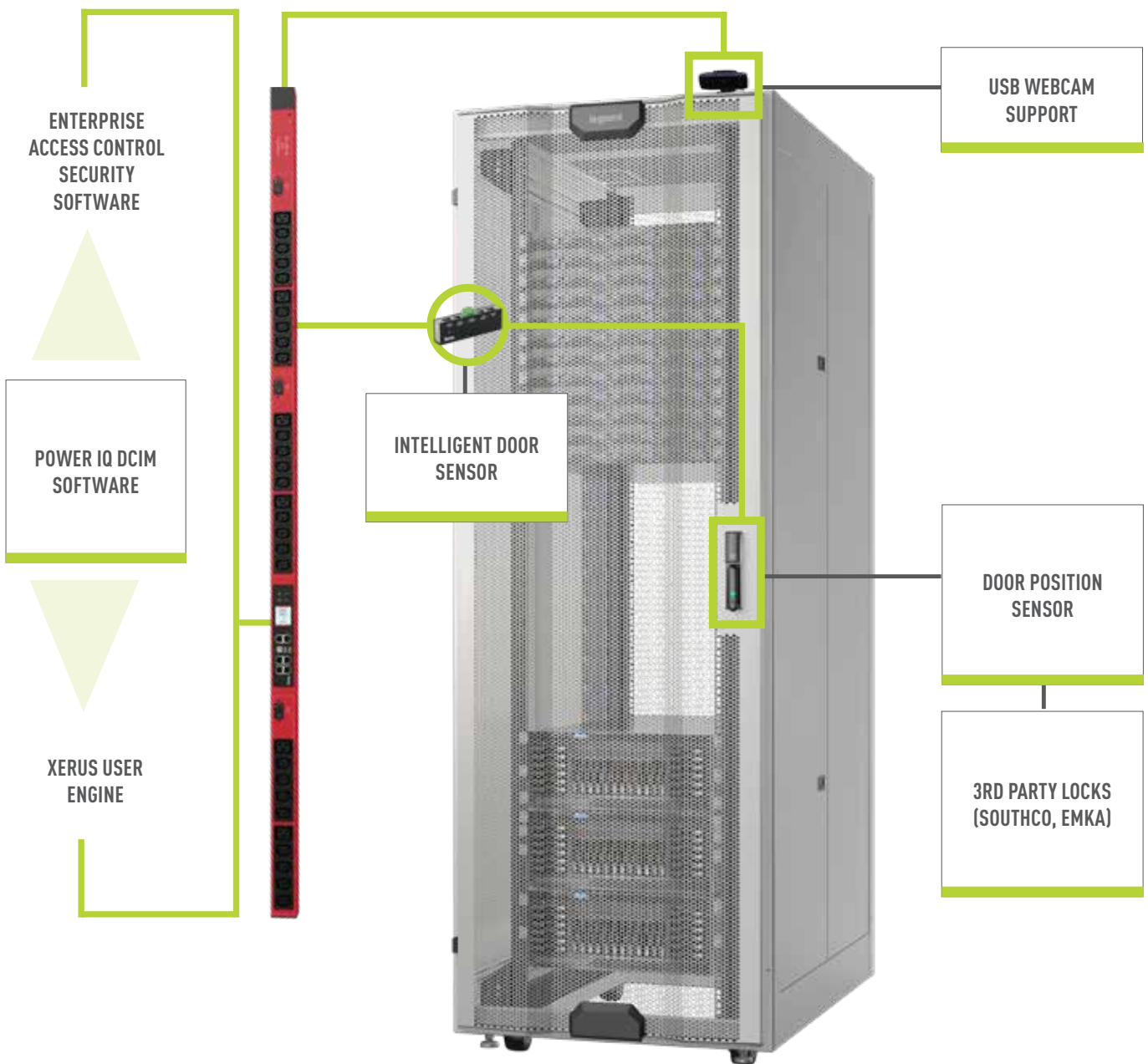

SMART RACK CONTROLLER



This innovative smart rack monitoring solution is installed independent of intelligent PDUs and helps data center and facilities managers to ensure uptime by monitoring racks for possible hot spots, save on cooling costs by confidently raising data center temperatures and make strategic decisions on environmental design and modifications.

- DUAL POWER INPUT FOR REDUNDANCY
- IX7 CONTROLLER WITH DUAL ETHERNET, LCD, ENHANCED CAPABILITIES
- 0U OR 1U FLEXIBLE MOUNTING OPTION

* During 2020 additional SRC models will be released. Contact your local Raritan product specialist for the latest offering.

FEATURES AND BENEFITS

- USB Webcam Support
- Supports up to 128 sensors
- Wired or WiFi Network Ready
- Web Browser Accessible
- Receive Advanced Alerts

SMART SENSORS

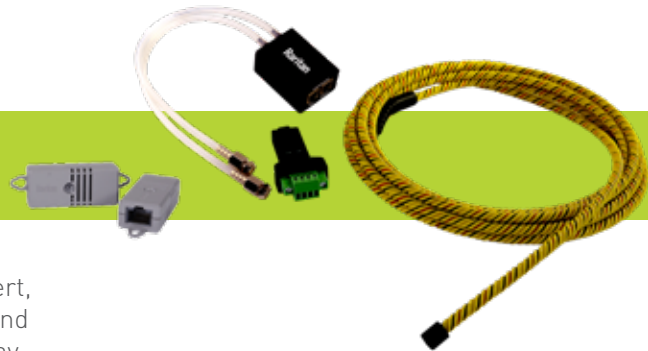

SmartSensor™ environmental rack sensors monitor, alert, and deliver data points so you get the accurate insight and keep your data center in healthy condition. Plug-and-play sensors that seamlessly work with Raritan power products and DCIM Power IQ software allow for rapid deployment and maximum uptime.

INNOVATIVE FEATURES

- Removable Sensor Heads (RJ45)
- SNMP and LED Alerting
- Daisy Chainable (up to 32 Sensors)
- High Accuracy and Reliability

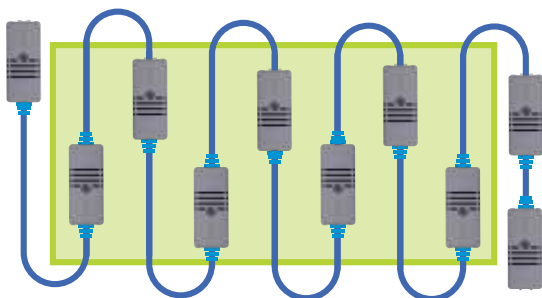



* Some part numbers listed on the page may deviate from the current offering as they are planned for launch during 2020. Please speak to your local Raritan product specialist for more information.

¹ Additional temperature and humidity sensor options are available.

² The American Society of Heating, Refrigerating and Air-Conditioning Engineers (ASHRAE) recommends measuring the cool air entering IT equipment near the bottom, in the middle, and near the top of each IT rack.

ASSET MANAGEMENT



INTELLIGENT ASSET TAGS & SENSORS

Intelligent asset management automates IT asset tracking to help you better understand exactly what you have and where it's located. Even modest-size data centers have an enormous number of IT assets, from servers to storage networking equipment.

Tracking these assets is often accomplished using Excel® spreadsheets and Visio® diagrams, or by developing a home-grown system, which can be very labor intensive. However, if you miss a few moves, adds or changes, it can become a challenge to know what you have and where it's located. And while RFID tags have also been used to track assets, RFID readers are unreliable if they are closely packed in a metallic environment such as a rack. They can be expensive, too, especially when tagging hundreds of devices.

Raritan's unique Asset Management Tags (AMT) and Asset Management Sensors (AMS) provide robust readings since they do not rely on radio frequencies, but on hardwired connections. Combined with DCIM software, data center operators can have an accurate, automated, real-time inventory of all IT assets and their location, down to the 1U level.

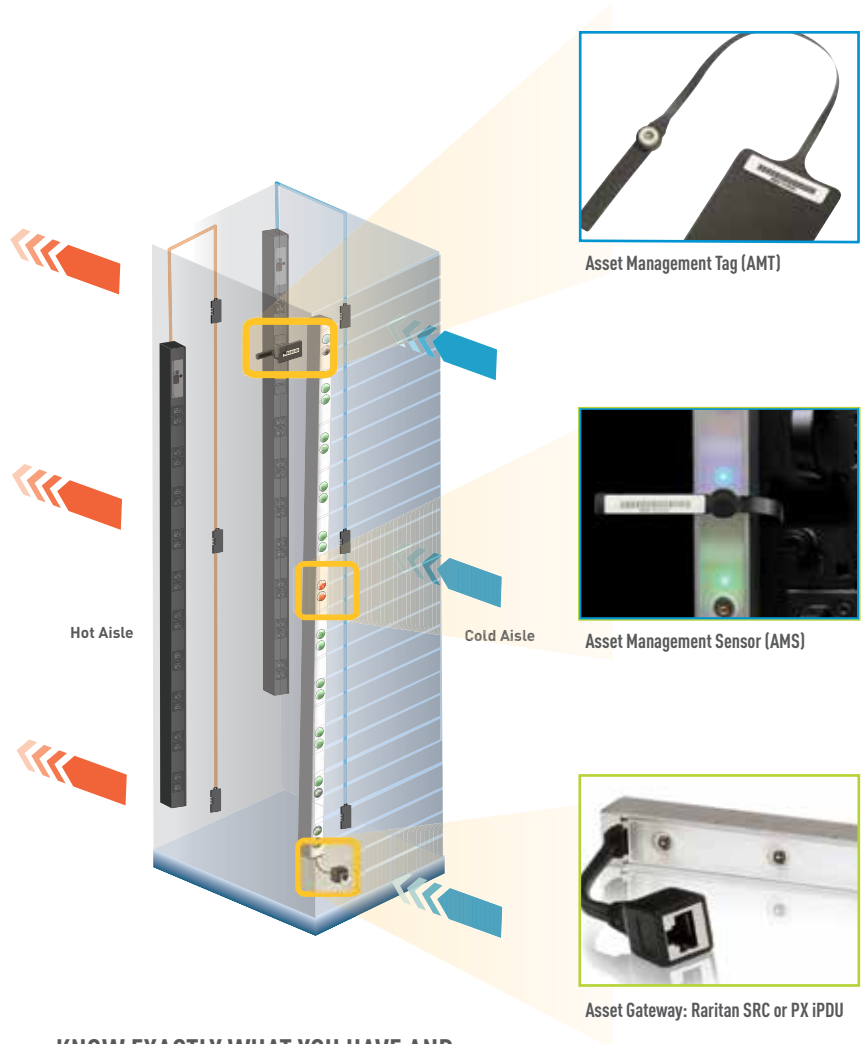

KNOW EXACTLY WHAT YOU HAVE AND WHERE YOU HAVE IT, DOWN TO 1U

POWER & RACK MANAGEMENT PRODUCT OVERVIEW

Power



INTELLIGENT PDUs

Intelligent rack power distribution units (iPDUs) include outlet switched, outlet metered, unit metered, and more. Available in single and 3-phase.

Power



INLINE METERS

Inline power meters that easily add power, energy and rack environmental data collection capabilities to stand-alone IT equipment or racks that have unmonitored PDUs.

Power



TRANSFER SWITCHES

The hybrid rack transfer switches use electromechanical relays and silicon-controlled rectifiers (SCRs) to transfer a load between two sources, should one source fail ensuring uptime.

Monitoring



BRANCH CIRCUIT MONITORS

The BCM series of intelligent branch circuit meters provide power and energy data on branch circuits and mains in an electrical service entrance or a remote power panel.

Security

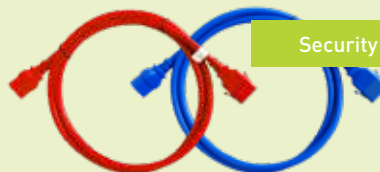

SECURELOCK™ POWER CORDS

Prevent accidental power cord disconnects with SecureLock - an integrated locking system of power cords and rack PDU outlets which secures power cords to rack PDUs.

Security



SMARTLOCK DOOR ACCESS

Raritan's SmartLock is an electronic door access and control system which provides an easy to deploy and economical networked locking solution for all types of data center enclosures.

Environmental



SMART RACK CONTROLLERS

The smart rack controller is a central access point for all of Raritan's environmental sensors such as temperature and humidity, and in conjunction with Sunbird's data center infrastructure management solution (DCIM) provides sensor readings and asset management.

Environmental



ENVIRONMENTAL SENSORS

Environment sensors such as temperature, humidity, airflow, air pressure, water, and contact closure help data center managers identify hot spots, efficiently and optimally cool equipment, prevent costly downtime, and maintain data center security.

Asset Management



INTELLIGENT ASSET TAGS AND SENSORS

Raritan's Asset Management Tags and Sensors, combined with Raritan's DCIM software, provide an accurate, automated, real-time inventory of all IT assets and their locations.

Monitoring



ENERGY MANAGEMENT AND POWER MONITORING SOFTWARE

Power IQ powered by Sunbird Software Inc. enables data center managers to closely monitor and efficiently utilize their existing data center power infrastructure.

ACCESS MANAGEMENT

ACCESS MANAGEMENT, PERFORMANCE AND SECURITY

Over 30 years and more than 50,000 deployments globally, Raritan has been ranked the leading provider of KVM-over-IP switches*.

IT administrators and infrastructure staff of IT test labs, data centers, broadcast, telecom and control rooms, rely daily on the performance and enterprise-level feature set of Raritan's KVM and serial console switches to keep their mission-critical applications running.

Our products stand out when it comes to speed, performance, security, and functionality. The resolutions of KVM-over-IP switches in many cases can now match those of analog switches and all Raritan products come with the highest level of encryption to improve the security.

Throughout its history, all of Raritan's KVM-over-IP switches and serial consoles have at some stage been awarded by the international press and industry for its innovation, performance, and enterprise level feature set. In actual fact, Raritan has been acknowledged for many 'industry firsts'.

* Raritan holds a 23 percent global market share based on revenue according to IHS Markit | Technology, now a part of Informa Tech (2019 research).



**"TECHNOLOGY BORN
OUT OF PASSION"**



CENTRALIZED INFRASTRUCTURE MANAGEMENT



COMMANDCENTER® SECURE GATEWAY

Gain consolidated access to physical and virtualized servers, serial devices and Raritan's Dominion appliances from a single, secure appliance.

Raritan's CommandCenter Secure Gateway (CC-SG) provides IT and lab organizations with secure and consolidated access and control of all technology platforms at the application, operating system and BIOS level.

CC-SG's single pane of glass helps simplify remote management and expedite troubleshooting of your physical and virtual servers, intelligent PDUs, and serial devices. Plus, it helps you maximize uptime and productivity.

From small and medium server rooms to large enterprises with multiple data centers, CC-SG is relied upon worldwide for secure and consolidated remote access and control.

CC-SG directly provides remote power control for Raritan PX and Servertech CDU1 and PRO2 PDUs and also integrates with Power IQ® for remote power control of Raritan and third-party devices.

FEATURES AND BENEFITS

- Centralized Gateway to your IT Infrastructure
- Centralized Authentication, Authorization and Logging
- Mobile and Java-Free Access
- Linux®-based Appliance Architecture with End-to-End Encryption (256-bit AES), Authentication and Policy Based Access of Target Devices
- Audit Trail Reporting
- Integrates with Power IQ® for Remote Power Control
- Choose from Hardware or Virtual Appliance
- Dominion User Station integration

Out-of-Band KVM and Serial Access



Raritan Dominion® Solutions

- KX III, SX II, KXS II, KX IV-101
- Rackmount and blade servers
- Network and serial devices
- Raritan and Servertech Intelligent PDUs

Remote Power Control



Power IQ Integration

- Power Control of Raritan PX Intelligent PDUs and Servertech CDU1 and PRO2 PDUs
- PIQ Monitoring Software Integration

Virtual Machines



VM ware



CommandCenter is available as a hardware or virtual appliance

In-Band Data Center Access Solutions



IP Tools

- RDP
- VNC
- SSH
- Telnet
- Web Browser

Service Processors

- iLO/iLO2
- DRAC
- RSA
- IPMI
- IMM

ENTERPRISE KVM-OVER-IP



DOMINION® KX III

The Dominion KX III is Raritan’s flagship enterprise-class KVM-over IP switch. With industry leading video performance, security, and enhanced reliability, the Dominion KX III outperforms the competition. With standard features such as DVI /HDMI / Display-Port digital video, VGA analog video, audio, virtual media, smart card/CAC, and mobile access, the Dominion KX III is suitable for both general computer and dynamic broadcast applications.

It’s ideal for server rooms, IT test labs, and the largest enterprise data centers. KX III offers high performance web-based remote management of servers, storage, and network devices and virtually any application. Deploy individually, or centralize with Raritan’s CommandCenter Secure Gateway.

Fast connections and subsecond switching available with the DKX3-808 model.

Continue reading on the next page to learn more about our high performance User Stations and wide range of computer interface modules (CIMs).

ADD SERIAL ACCES TO YOUR KVM-OVER-IP SWITCH



2 or 4 port models are available.

The Dominion Serial Access Modules (DSAM) allow users to connect serial devices with Java-free user access from the Dominion KX III.

AMAZING DIGITAL VIDEO & AUDIO PERFORMANCE

30 frames-per-second, high definition video support over-IP. The 1920x1200, high definition, digital video performance supports broadcast and other dynamic, video-intensive applications. A DVI digital local port provides fast, at-the-rack access.

MOUSE IN SYNC

Raritan KVM switches come with the unique Absolute Mouse Synchronization™. This feature not only provides perfect mouse synchronization without changing server mouse setting, it also gives a great user experience.

HIGH PERFORMANCE KVM-OVER-IP



JAVA Free



Military Grade Security & Reliability



Dual Power for Maximum Uptime





DOMINION® USER STATIONS

HIGH PERFORMANCE IP KVM SWITCH ACCESS

The Dominion KX User Stations are standalone appliances for high performance IP access to servers connected to Dominion KX III and KX IV switches via RDP, VNC & SSH, along with optional CommandCenter integration.

The slim form factor allows them to easily sit on a desk, be mounted in a standard 19" rack, or VESA-mounted on the back of a monitor. They are deployed using standard Cat5 cabling and Ethernet/IP technology. You can simultaneously access, view, and control multiple servers, spread across one, two, or three monitors. Gain web-based remote control of User Stations connected to wall monitors in studios and control rooms.

REPLACE OUTDATED ANALOG MATRIX SWITCHES

The Dominion User Stations can replace outdated analog matrix switches, supplement inflexible broadcast systems or be deployed anywhere hassle-free IP access is needed. They are perfect for broadcast, labs, studios, control rooms, offices, and data centers.



DOMINION KX III-UST

The Dominion KX III User Station is recommended for use with the KX III, one or two monitors, and servers up to 1080p.



DOMINION KX IV-UST

The new, high performance Dominion KX IV User Station is recommended for use with the Dominion KX IV-101. This solution comes with video resolutions up to 4K, a larger number of KVM sessions, and up to three monitors.

The User Stations now also integrate with CommandCenter Secure Gateway (CC-SG) to support centralized login and access for large deployments.

ACCESS & CONTROL REMOTE BIOS-LEVEL

Dominion KX III has the industry's highest performing and most flexible KVM-over-IP technology. Users can access Dominion KX III from LAN, WAN, Internet, mobile & dial-up, allowing admins BIOS-level access to troubleshoot, reconfigure, reboot and power cycle servers remotely.

VIRTUAL MEDIA OVER IP

Each Dominion KX III comes equipped with virtual media to enable remote tasks, such as software installation, remote booting and diagnostics, using the widest variety of media storage (CD, DVD, USB, internal and remote drives, and images).

MILITARY GRADE SECURITY

With Raritan's Dominion KX III, you can meet government and military security mandates, including: AES & FIPS 140-2 encryption, Common Access Card (CAC) authentication, and IPv6 networking.

ELIMINATE JAVA USE

You can finally say so long to Java on Windows Platforms with the Active KVM Client (AKC). Enjoy Java-free KXIII administration on all platforms.

COMPUTER INTERFACE MODULES (CIMS)

A suite of multiplatform Dominion® CIMS to connect to VGA, DVI, HDMI and DisplayPort, USB with virtual media, Sun®, Sun USB and serially controlled servers, as well as popular blade server models from HP®, IBM®, Dell® and Cisco®.

Dominion Computer Interface Modules (CIMS) and Serial Access Modules (DSAM)							
D23CIM-DVUSB-HDMI	D2CIM-DVUSB-DVI	D23CIM-DVUSB-DP	D23CIM-DVUSB	D2CIM-VUSB-C	D2CIM-VUSB	DCIM-USB62	DCIM-PS2

KVM-OVER-IP FOR THE SMALLER ENTERPRISE



DOMINION® LX II

Dominion LX II KVM-over-IP switches give one or two remote users and one local user, Java-free, BIOS-level access and control of 8 or 16 servers (expandable to 256 servers with tiering), and virtual media.

You can choose from:

- 3 KVM-over-IP Switches
- 3 Integrated LCD KVM Drawers

LX II appliances, designed for small to midsize businesses (SMBs), support a wide variety of computer and serial devices with VGA, DVI, HDMI, USB-C and DisplayPort video. Productive, KVM-over-IP connections up to 15 frames-per-second with video resolutions up to 1080p and 1200p are supported for digital and analog video.

For the full range of available Dominion CIMs, see page 19.

FEATURES AND BENEFITS

- Economical, reliable and secure remote access and management
- Anytime/anywhere, Java-free, browser-based remote access
- Manage and maintain equipment without travel
- Remote software installation, booting and diagnostics
- Multi-vendor support for diverse computer and network devices

INTEGRATED KVM SWITCH / LCD COMBINATION

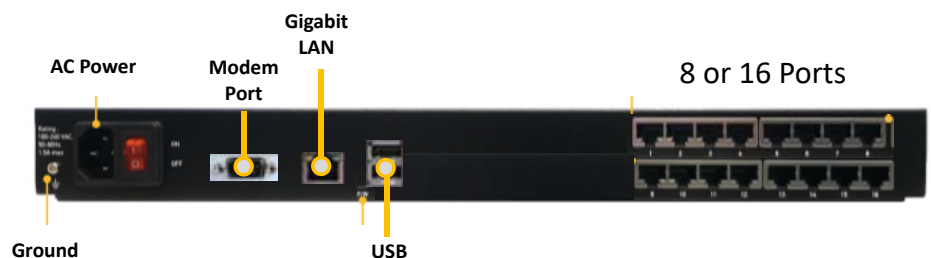

Three combination LX II KVM switch and T1700-LED LCD drawer models provide at-the-rack and remote, IP-based management in a 1U integrated unit.

SINGLE PORT KVM-OVER-IP (4K VIDEO)



DOMINION® KX IV-101

The Dominion KX IV-101 (DKX4-101), Raritan's highest performing KVM-over-IP switch, provides a new level of Ultra HD 4K performance for remote access and management. More powerful and flexible than any other KVM-over-IP solution, it supports higher video resolutions, faster frame rates, higher video quality, and faster virtual media.

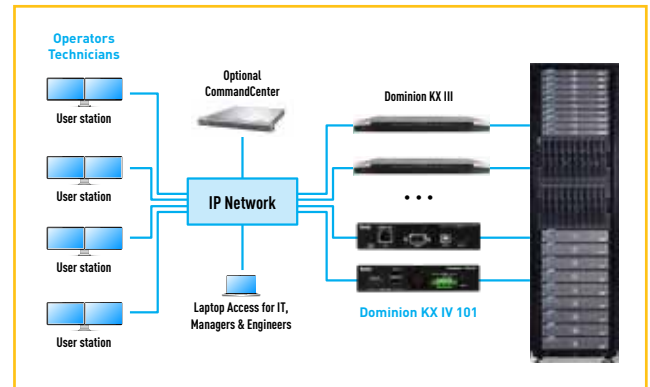

BROADCAST & CONTROL ROOM SOLUTION

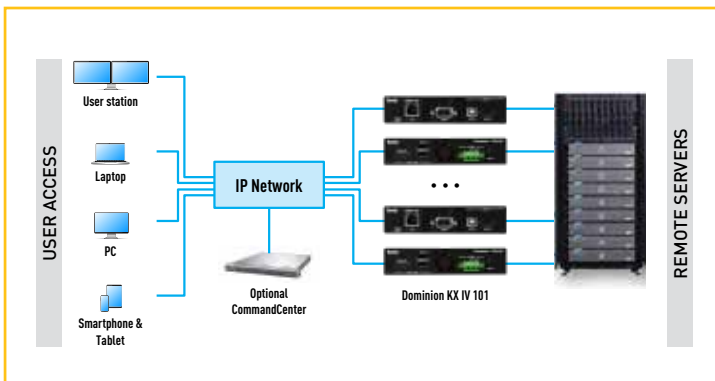

SINGLE OR MULTIPLE KX4'S

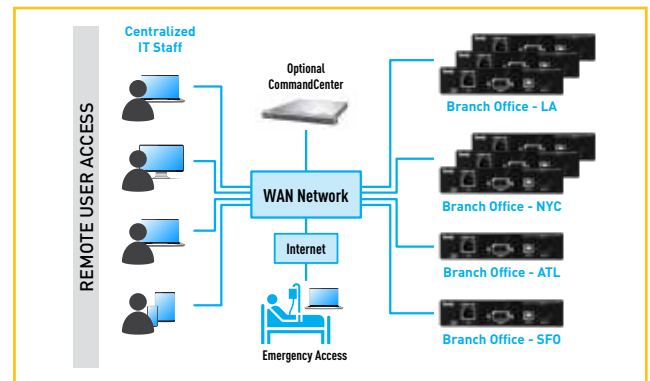

REMOTE OFFICE / FACILITIES / EDGE

SECURE SWITCH (RSS)

The Raritan Secure Switches (RSS) provide the productive, secure desktop access that government and military agencies require to protect systems from hackers and cyberattacks. These switches are lab-tested and certified to meet the strict intrusion. In addition, Common Access Card (CAC) authentication is supported, and unauthorized USB peripherals (i.e. flash drives) are blocked.



FEATURES AND BENEFITS

- Complies to NIAP Protection Profile Version 3.0
- Isolation between computers at different classification levels
- Analog (VGA) or digital (DVI/HDMI) video mode
- Support for Common Access Card (CAC) / SmartCard authentication
- Built-in, internal power supply

SERIAL CONSOLE SERVER



"JAVA-FREE SERIAL-OVER-IP
ACCESS TO ENHANCE YOUR
PRODUCTIVITY"

DOMINION® SX II

The Dominion SX II is Raritan's next-generation Serial Console Server (Terminal Server) that provides IT and network administrators secure IP access and control of serial devices, anytime, anywhere. The new SX II is the most powerful, secure, reliable, easy-to-use serial-over-IP device on the market. SX II provides convenient access to networking devices, servers, PDUs, telecommunications and other serial devices.

POWERFUL HARDWARE PLATFORM

- Dual power supplies and dual gigabit Ethernet LAN ports, with automatic failover
- 4, 8, 16, 32 and 48 port 1U secure appliances (optional telephone modem)

SERIAL-OVER-IP ACCESS

Complete CLI access and management via SSH, Telnet and web-browser, with convenient direct port access methods. Two script-based automatic configuration methods (TFTP server and USB stick) are available. Scales to thousands of devices with Raritan's CommandCenter Secure Gateway.

BROAD SERIAL DEVICE SUPPORT

Enjoy comprehensive serial device access to a wide range of equipment. Support for operating speeds of 1,200 to 230,400 bps with flexible, per-port serial options.

DOMINION SX II OFFERS MULTIPLE FORMS OF SERIAL-OVER-IP ACCESS

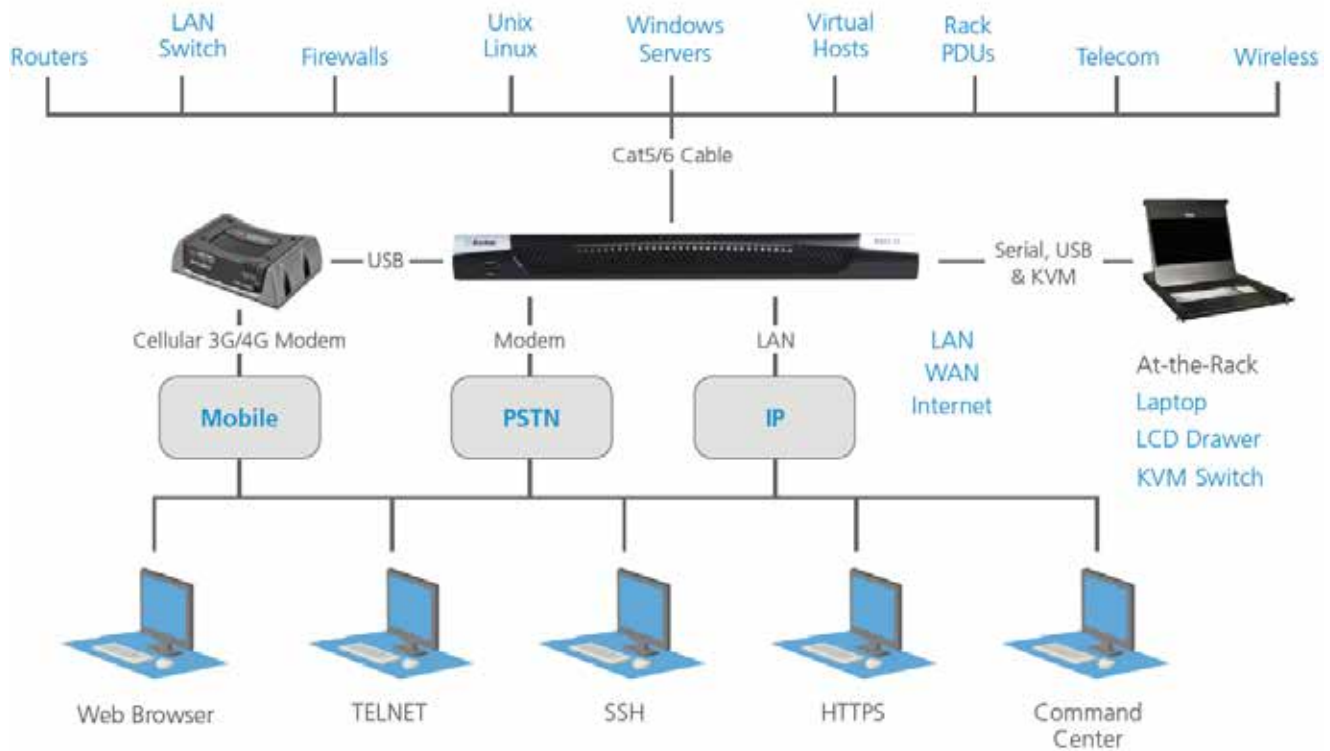

**SECURE IP ACCESS
MILITARY GRADE SECURITY**

Achieve military-grade security levels, including: strong AES and certified FIPS 140-2 encryption, LDAP/RADIUS/Active Directory authentication, and dual stack IPv4 and IPv6 networking.

3G/4G MODEM ACCESS

The SX II offers an optional internal telephone modem and can connect to an external cellular (3G/4G) modem for emergency access.

**AUTOMATIC DTE/DCE SERIAL
PORT DETECTION**

For fast installations, the SX II supports straight Cat5 connections to Cisco and other compatible RJ-45 devices, without rollover cables. The SX II can also directly replace the first generation SX with compatible serial device connections.

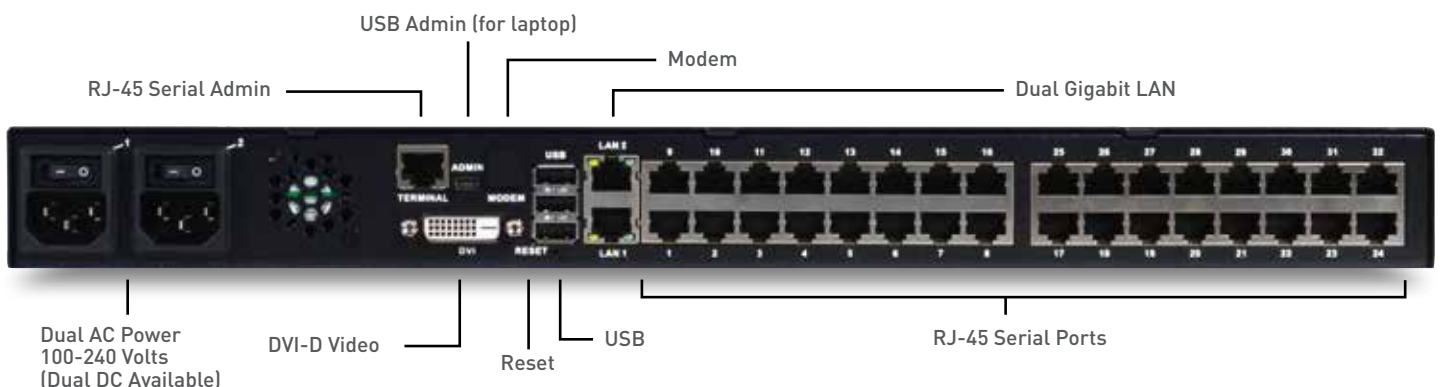

CAT5 KVM and CONSOLE DRAWERS



MASTERCONSOLE® DIGITAL Cat5 Analog/Digital KVM Switch

Cat5 KVM switches for small to mid-sized (SMB) IT environments. Ideal for performing system maintenance, administration, and troubleshooting, Master Console Digital supports the latest digital video interfaces and analog video, along with stereo audio.

Features Include:

- Single or dual user to control 8, 16 or 32 servers
- Control up to 1024 servers by cascading
- Support VGA/DVI/HDMI/DP digital video interfaces



MASTERCONSOLE® DIGITAL LED Integrated KVM Switch

LCD console drawers with integrated KVM switch for small to mid-sized (SMB) IT environments. The product features a 17" LCD drawer with an integrated KVM switch. The digital KVM interface supports VGA, DVI, HDMI, DisplayPort video and stereo audio.

Features Include:

- 1U, small form factor design
- Single user of control 8 or 16 servers
- Control up to 512 servers by cascading
- Support VGA/DVI/HDMI/DP digital video interfaces



LED-BACKLIT LCD CONSOLE DRAWERS Rackmount Console Drawers

Integrated, 1U console drawers for at-the-rack access of servers and KVM switches in data centers, server rooms, and other space critical environments. 17" and 19" units provide convenient and powerful access and control.

Features Include:

- DVI-D and VGA video inputs make it perfect for use with the Dominion® KX III
- LED-backlighting provides up to 20-50% energy savings over current LCD technology
- Accurate image rendering and video performance for sharp, clear pictures

KVM and SERIAL ACCESSORIES



CAT5 REACH DVI HD

The Cat5 Reach DVI HD provides 1080p HD video quality while enabling extended remote access to DVI and VGA ports on PCs, servers or KVM switches.



COMPUTER INTERFACE MODULES (CIM)

Raritan offers a full line of CIMs to support a variety of platforms and applications, including USB, DVI, HDMI, and more.



CONVERTERS, ADAPTERS AND EMULATORS

Raritan's full line of converters, adapters and emulators for support of multi-platform devices.



CABLES

From KVM user console ultra thin cables to power cords for rack PDU's and inline meters, Raritan has an answer for all your cabling needs with an array of options and sizes to support all platforms in your data center.



RACKMOUNT BRACKETS

Make sure your Raritan devices fit perfectly in your rack opening with these custom rack mount brackets.

KVM & SERIAL PRODUCT OVERVIEW

For over 30 years Raritan has been at the forefront of developing cutting edge technology. From enterprise solutions to small businesses Raritan's KVM solutions are unmatched in quality and durability. Below you can find our current KVM portfolio.



Access Mgmt

COMMANDCENTER® SG

An easy to deploy, plug-and-play appliance that provides a single pane of glass access to all servers, storage, and network equipment.



Security

SECURE SWITCH

Proven desktop access solution for guarding against cyber intrusion for government and military agencies.



KVM-Over-IP

DOMINION® LX II®

Designed for small to midsize businesses (SMBs), LX II switches support a wide variety of computer and serial devices with VGA, DVI, HDMI, USB-C and DisplayPort video.



KVM-Over-IP

DOMINION® KX III

Enterprise-class, secure KVM-over-IP switch that provides BIOS-level remote management of up to 64 multi-platform servers and serial-based devices in a single switch.



KVM-Over-IP

DOMINION® KX IV/KX III USER STATIONS

Standalone appliances for high performance IP access to servers connected to KX III and KX IV-101 switches.



KVM-Over-IP (4K)

DOMINION® KX IV-101

Raritan's highest performing KVM-over-IP switch, provides a new level of Ultra HD 4K performance for remote access and management.



Serial

DOMINION® SERIAL ACCESS MODULE (DSAM)

DSAM allows users to connect serial devices with Java-free user access from the Dominion KX III.



Serial

DOMINION® SX II

Serial console server provides admins secure remote access, monitoring, and control all of their serial devices.



Serial

DOMINION® KSX II

Solution for branch/remote offices and retail stores and racks with both serial and KVM-managed devices.



Analog

CAT5 REACH® DVI HD

Provides 1080p HD video quality while enabling extended remote access to DVI and VGA ports on PCs, servers, AV devices or KVM switches.



KVM Drawers

MASTERCONSOLE® DIGITAL

Next generation of Cat5 KVM switches for SMB IT environments. It is ideal for performing system maintenance, administration, and troubleshooting.

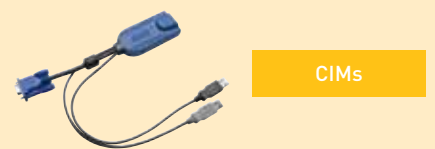

CIMs

COMPUTER INTERFACE MODULES (CIMs)

Raritan offers a full line of CIMs to support a variety of platforms and applications including HDMI, DisplayPort, DVI, and more.



FOLLOW US ON



www.raritan.com/eu



www.linkedin.com/company/raritan



marketing.europe@raritan.com